

Overview

- Flashable red LED bar light
- Red (625 nm)
- Radiation angle 100°
- Integrated LED controller with 4 operating modes
- IP54



Picture similar



Technical data

General data

Manufacturer Baumer

Illumination data

Color / Peak wavelength red (625 nm)

Beam angle 100°

Operating modes steady light
steady light with brightness control
flashed light with PNP sourcing
flashed light with NPN sourcing

Recommended illumination distance 10 mm ... 500 mm

Electrical data

Connectors M8/4-pin male connector

Operating voltage 24 VDC

Maximum flash duration 20 ms

Power consumption approx. 18 W (steady light)
approx. 56 W (flashed light)

Mechanical data

Construction design bar light

Dimensions 54 mm x 310 mm x 23 mm

Dimensions luminous area 45 mm x 300 mm

Material of cover glass PMMA (acrylic glass)

Material of housing aluminum (anodized, black)

Weight ≤ 560 g

Environmental conditions

Operating temperature 0 ... +30 °C
0 ... +45 °C with thermal connection

Conformity CE
RoHS

Humidity 30 ... 70 %

Protection class IP 54

Dimension drawing

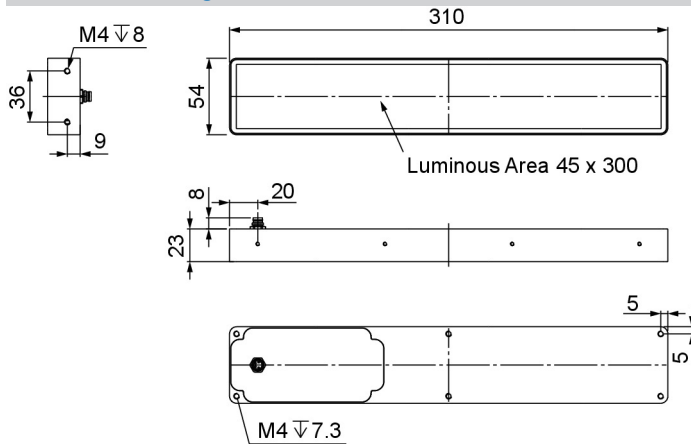

Principle

Steady light

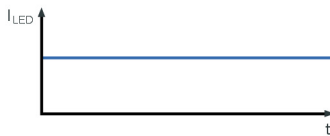

Current is fixed depending on the respective lighting model.

Trigger

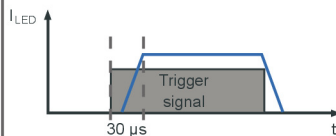

Trigger (Pin3) is a high resistance current sink with 0.2 mA for 5 V and 5 mA for 24 V.
High = 5...24 V=ON
Low = 0...1 V=OFF

Brightness control

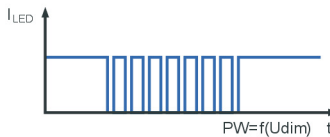

DIM (Pin2) is used as brightness control and operation mode switch. It's a high resistance current sink with 0.2 mA for 5 V and 1 mA for 24 V.
PWM frequency: 3.8 kHz
Min. exposure time: 5 ms

Flash light

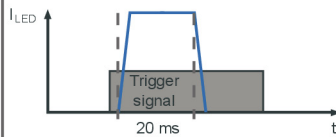

Triggered flash light with overdrive current and time-out for LED protection.
Max. flash time: 20 ms
Min. flash time: 100μs
Latency (trigger -> LED ON): max 30μs
Max. clock speed: 1 kHz
Max. duty cycle: 25 %

Pin assignment

M8 socket, 4-pin

Pin	Core color	Description
1	brown	24 VDC
2	white	Dim
3	blue	Trigger
4	black	Ground

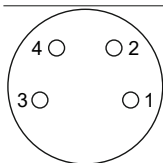

Connection examples

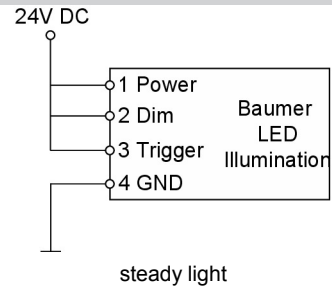

steady light

Connection examples

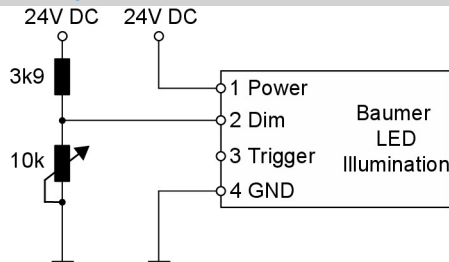

steady light with brightness control

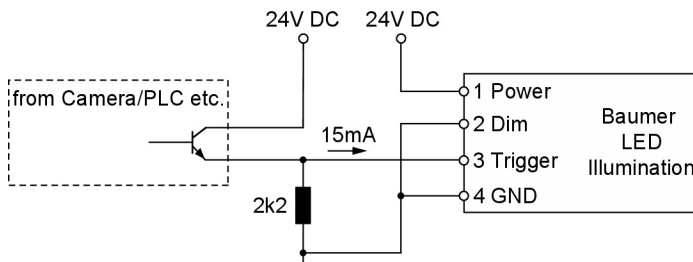

flashed light PNP sourcing

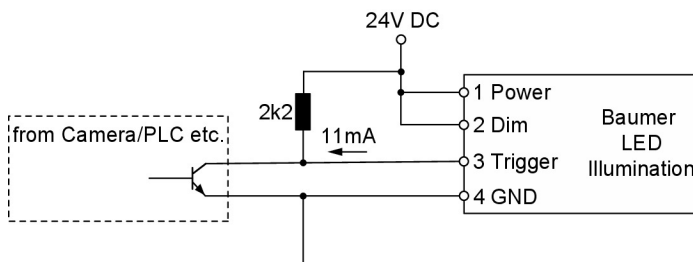

flashed light with NPN sourcing

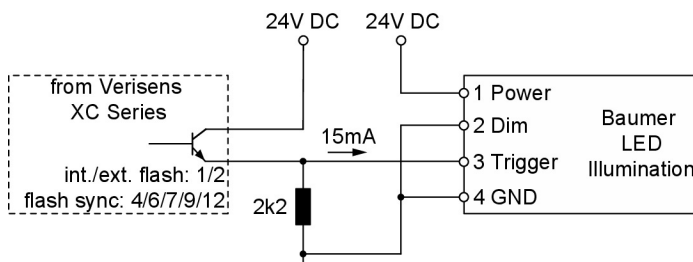

Connection scheme VeriSens®

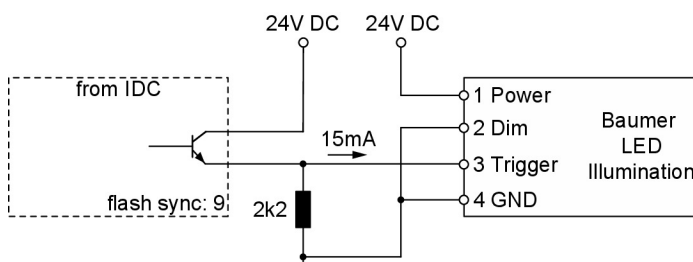

Connection scheme IDC

Safety notes



Read the warning and application instructions carefully and completely before working with this device.

Only operate the illumination in compliance with the prescribed protective measures. It is essential to ensure compliance with the permissible ambient conditions.

- The device is only designed for indoor use.
- **Light:**
Due to the risk of eye irritation or injury, it is not recommended to look directly into the light source. The illumination system must be switched off before installation and/or maintenance. The device must not be used if incorrect operation may cause personal injury.
- **Heat:**
The surface temperature may exceed 60 °C if heat dissipation is inadequate or when the illumination is operated in flash mode with an excessively high duty cycle. Keep away from flammable materials by all means.
- **Electricity:**
The housing is electrically isolated from the power supply ground. Exceeding the permissible input voltage U_{in} or $U_{LED(+)}$ may cause damage to the device or significantly shorten the service life of the LEDs within the device.
- **Usage:**
Do not apply mechanical stress to the luminous area during operation. This will result in inhomogeneous light emission.
- **Cleaning:**
The light surface must be cleaned with a conventional glass cleaner and a soft cleaning cloth. Avoid using other cleaning agents as these can damage the device.
- **Installation:**
To maximize the service life of the LED, it is important to avoid heat build-up. To do so, install the lighting with a proper thermal connection. Be sure to hand-tighten the cables, do not overtighten.