



## Description of functions and interfaces

**OF10 with IO-Link interface**  
Fiber optic sensor

**EN-US**

# Table of contents

- 1 About this document ..... 5**
  - 1.1 Purpose and scope of application ..... 5
  - 1.2 Applicable documents ..... 5
  - 1.3 Labels in this manual ..... 5
  - 1.4 Warnings in this manual ..... 6
- 2 Structure and function ..... 7**
- 3 Interfaces ..... 8**
  - 3.1 IO-Link ..... 8
  - 3.2 OLED display ..... 9
- 4 Process data ..... 10**
- 5 Operating functions ..... 11**
  - 5.1 AUTOSET function ..... 11
  - 5.2 AUTOSET Percent ..... 15
  - 5.3 Detect Mode ..... 16
  - 5.4 Response Time ..... 17
  - 5.5 Hysteresis ..... 18
  - 5.6 Anti-Crosstalk ..... 21
  - 5.7 Timer/counter function ..... 22
  - 5.8 Q2 IO function ..... 25
  - 5.9 MDC configuration ..... 27
  - 5.10 Display-Mode ..... 28
  - 5.11 Lock-Mode ..... 29
  - 5.12 Factory settings ..... 30
- 6 Diagnostic functions ..... 32**
  - 6.1 Signal strength ..... 32
  - 6.2 Switching point ..... 32
  - 6.3 Device status ..... 32
  - 6.4 Identification ..... 33
- 7 Annex ..... 34**
  - 7.1 IO-Link ..... 34
    - 7.1.1 PDI ..... 34
    - 7.1.2 Identification ..... 35
    - 7.1.3 Parameter ..... 35
      - 7.1.3.1 Switching Signal Channel 1 (SSC1) ..... 35
      - 7.1.3.2 Teach-in ..... 38
      - 7.1.3.3 SwitchCounts ..... 39
      - 7.1.3.4 Quality Parameters ..... 39
      - 7.1.3.5 MDC Configuration ..... 40
      - 7.1.3.6 Interface Parameters ..... 40

7.1.4	Diagnosis .....	41
7.1.4.1	Factory Diagnostics .....	41
7.1.4.2	Device Status Information .....	41
7.1.4.3	Service Functions .....	42

## List of illustrations

III. 1	IO-Link architecture.....	8
III. 2	Comparison of AUTOSET settings .....	13
III. 3	Diagram of the LO/DO switching logics .....	16
III. 4	Hysteresis .....	18
III. 5	Switching output behavior in mode <i>Single Point</i> and negative hysteresis ( <i>Left Aligned</i> ).....	19
III. 6	Switching output behavior in mode <i>Window</i> and negative hysteresis ( <i>Left Aligned</i> ) .....	19
III. 7	Switching output behavior in mode <i>Single Point</i> and negative hysteresis ( <i>Left Aligned</i> ).....	19
III. 8	Switching output behavior in mode <i>Window</i> and negative hysteresis ( <i>Right Aligned</i> ).....	20

# 1 About this document

## 1.1 Purpose and scope of application

This manual enables safe and efficient sensor parameterization. The manual describes the functions and is intended to support sensor installation and use.

The illustrations are examples only. Deviations are at the discretion of Baumer at all times. This manual is a supplement to the existing product documentation.

## 1.2 Applicable documents



- Download at [www.baumer.com](http://www.baumer.com):
  - Data sheet
  - EU Declaration of Conformity
- Attached to product:
  - Quickstart
  - General information sheet (11042373)

## 1.3 Labels in this manual

Identifier	Usage	Example
<i>Dialog element</i>	Indicates dialog elements.	Click <b>OK</b> .
<i>Unique name</i>	Indicates the names of products, files, etc.	<i>Internet Explorer</i> is not supported in any version.
Code	Indicates entries.	Enter the following IP address: 192.168.0.250

## 1.4 Warnings in this manual

Warnings draw attention to potential personal injury or material damage. The warnings in this manual indicate different hazard levels:

Symbol	Warning term	Explanation
	<b>DANGER</b>	Indicates an imminent potential danger with high risk of death or serious personal injury if not being avoided.
	<b>WARNING</b>	Indicates potential danger with medium risk of death or (serious) personal injury if not being avoided.
	<b>CAUTION</b>	Indicates a danger with low risk, which could lead to light or medium injury if not avoided.
	<b>NOTE</b>	Indicates a warning of material damage.
	<b>INFO</b>	Indicates practical information and tips that enable optimal use of the devices.

## 2 Structure and function

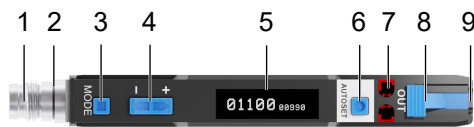

1	4-pin connection: M8 or cable	2	LED - activity indicator*
3	Mode button	4	Selector +/-
5	OLED display	6	AUTOSET button
7	Output LEDs	8	Locking lever
9	Fiber-optics port		

\* Only variant with M8 connector

The sensor can be deployed with every standard fiber optics with 2.2 mm adaptor sleeve and this way provides to right solution for most varied applications and installation conditions.

### Functional principle: through-beam sensor

Through-beam sensors detect interruptions in the light beam between transmitter and receiver caused by an object passing through.



The separate arrangement allows for long-range detection and large signal reserve capacities. Through-beam sensors are hence ideal for harsh environmental conditions (e.g. dust, dirt and moisture).

- The clearly defined and permanent active zone provides a high level of constant reproducibility throughout the entire detection range.
- The switching point is independent from object surface properties.

### Functional principle: Diffuse sensor

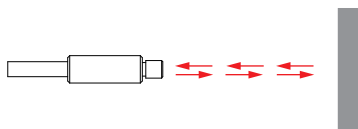

Diffuse sensors evaluate the intensity of light reflected by the object. One and the same sensing head accommodates both transmitter and receiver.

In other words, transmission and reception beams are co-axial. This allows for detection in narrow openings and the object's approaching direction does not matter.

## 3 Interfaces

This section describes the available interfaces for operator to sensor communication.

### 3.1 IO-Link

IO-Link enables manufacturer-independent digital, bidirectional point-to-point communication. For this purpose, actuators or sensors are connected to an IO-Link master by standardized 3-wire connecting cables.

The IO-Link interface serves for parameterization of the sensor functions. In addition, measurement data and the function-generated sensor and status information are digitally transmitted in the form of process data to the machine controller (PLC). Secondary data informing on the machine condition allow for continuous process monitoring and process optimization.

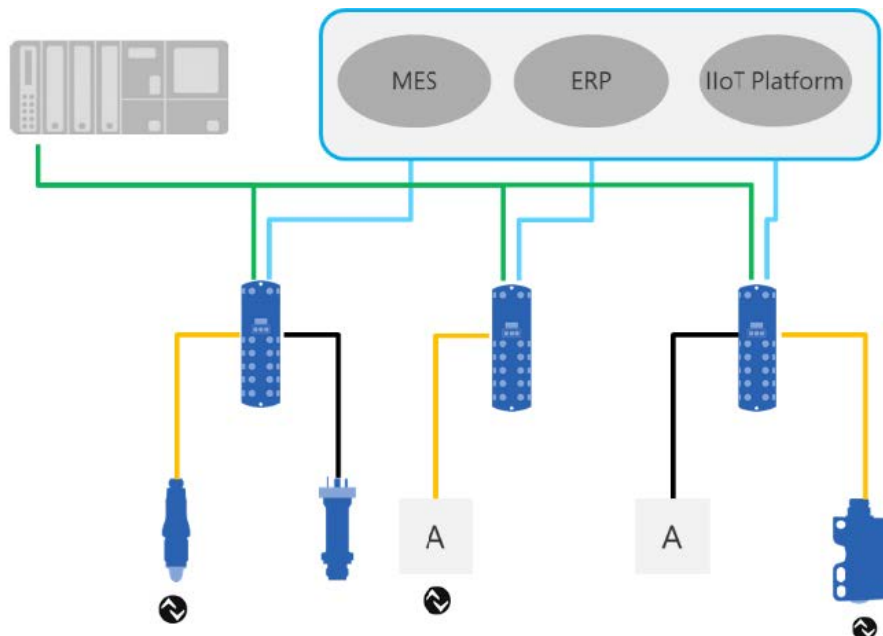

III. 1: IO-Link architecture

The IO-Link master clustering several sensors connects the controller via the respective fieldbus system, which is the so-called operational technology communication (OT communication). In addition, another Ethernet-based connection to the IO-Link master (e.g., via OPC UA or MQTT) enables direct communication between sensor and IT systems (IT communication).

There are two types of communication between IO-Link master and device.

- **Cyclic communication:**

transmission in real time - This data and information (process data) is used for process control in automation systems.

- **Acyclic communication:**

Time-uncritical communication for secondary data transmission or sensor parameterization.

To address both sensor functions and secondary data correctly, IO-Link interface description utilizes the so-called IODD (IO Device Description). IODD is available for download on the sensor website (download section). Digital sensor communication, secondary data and the option of direct sensor communication with the IT world makes IO-Link a cornerstone in Smart Factory.





## INFO

For evaluation, parameterization and use of IO-Link sensors, Baumer provides both IO-Link USB-C master and Baumer Sensor Suite. The IO-Link USB-C Master enables IO-Link devices to communicate with the computer without external power supply. Baumer Sensor Suite is a computer-based tool to understand and use IO-Link devices and to visualize sensor functions of different sensor brands. This allows for engineering both at the workplace and straight at the machine. Further information at [baumer.com/bss](https://baumer.com/bss).

## 3.2

### OLED display

The individual sensor functions are accessed using the display button MODE. Pressing MODE once will provide an overview of sensor settings. Every further press on the button will skip to the next setting.

#### Display layout

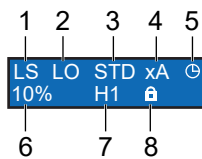

1	AUTOSET Mode	2	Detect Mode
3	Processing Mode	4	Anti-Crosstalk Channel
5	Timer	6	AUTOSET Percentage
7	Hysteresis	8	Lock Active

## 4 Process data

If the sensor is in IO-Link communication mode, the process data is exchanged cyclically between the IO-Link master and the sensor (sensor<>IO-Link master). The IO-Link master needn't explicitly request the process data.

Following process data is available:

### Process Data In (PDI)

For more detailed information on the following please refer to chapter [Annex \[▶ 34\]](#).

Bit Offset	Sub index	Function	Description
0	24	SSC1 (Switching Signal Channel)	Status of the switching output. <ul style="list-style-type: none"> <li>▪ Bit 0 = 0: Switching output is inactive.</li> <li>▪ Bit 0 = 1: Switching output is active.</li> </ul>
1	23	SSC2 (Switching Signal Channel)	
2	22	Quality	Signal quality status. <ul style="list-style-type: none"> <li>▪ Bit 2 = 0: Signal quality is good.</li> <li>▪ Bit 2 = 1: Signal quality is insufficient. The sensor should be checked for soiling.</li> </ul>
8	21	Scale	Alarm output status. <ul style="list-style-type: none"> <li>▪ Bit 3 = 0: Alarm is inactive. Sensor is functioning as required.</li> <li>▪ Bit 3 = 1: Alarm is active. The sensor must be checked. No measured value can be recorded.</li> </ul>
16 ... 31	1	MDC	Measurement data channel. This channel is for readout the sensitivity and quality values or number of SSC1 switching operations in the form of a 32-bit integer value.

Tab. 1: Process Data In

## 5 Operating functions

### 5.1 AUTOSET function

Function AUTOSET is for setting the sensor's switching point. The sensor provides different modes for setting the switching point.

To select the appropriate mode, find out first which type of setup mode is best for the respective application. The most common and easiest mode is **Light State**. That is sensor default. This mode can be used with both through-beam sensors and diffuse sensors.

#### Light State LS (Default)

Position the object to be detected in the most unfavorable light state and press AUTOSET. The switching point is set 10 % (default) lower than the light intensity of the beam received. Use the selector +/- to adjust the switching point.

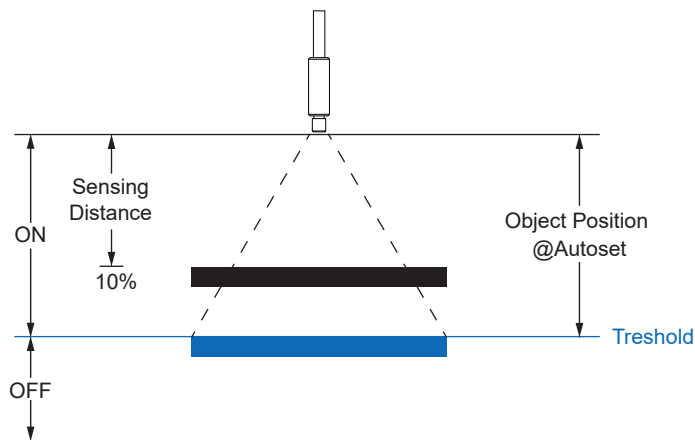

#### Dark State DS

Position the object to be detected in the most unfavorable dark state and press AUTOSET. The switching point is set 10 % (default) higher than the light intensity of the beam received. Use the selector +/- to adjust the switching point.

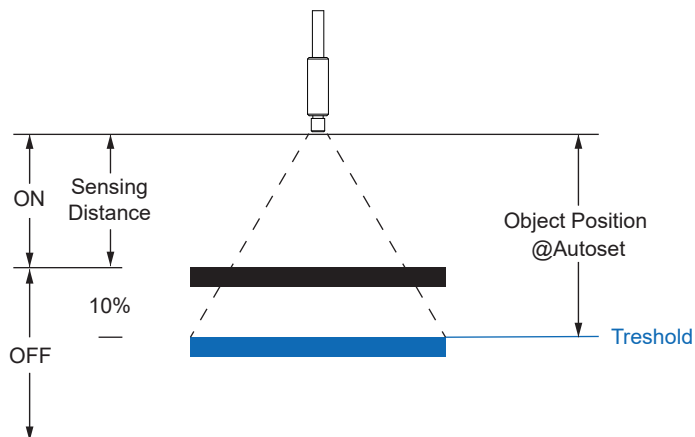

### Midpoint MP

Position the object to be detected in the place you like to set the switching point and press AUTASET. Use the selector +/- to adjust the switching point.

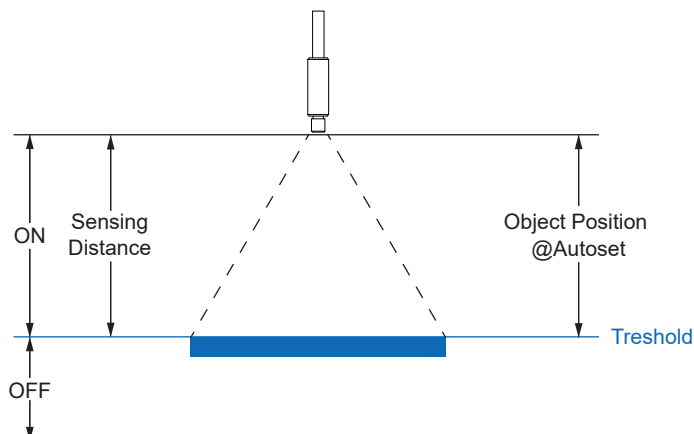

### Two-Point 2P

Position the object to be detected inside the sensing range and press AUTASET. Next take the object out of the sensing range and press AUTASET again. The switching point is set in the mid of both light intensities. Use the selector +/- to adjust the switching point.

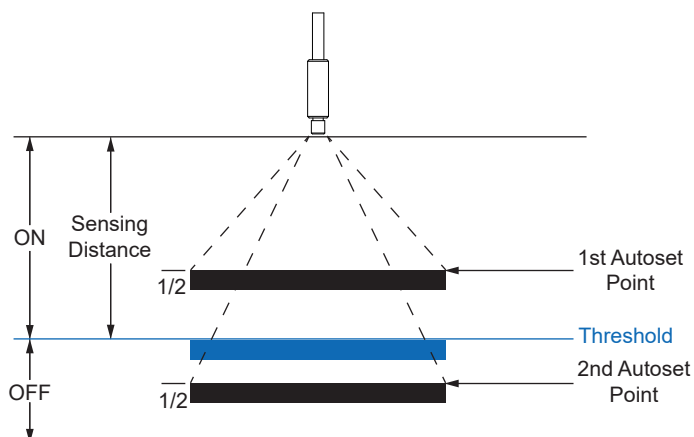

### Dynamic DY

Press AUTOSET to start dynamic AUTOSET. Now move the object at least once through the beam and press AUTOSET again to complete dynamic AUTOSET. The switching point is set between the highest and lowest light intensities received. Use the selector +/- to adjust the switching point.

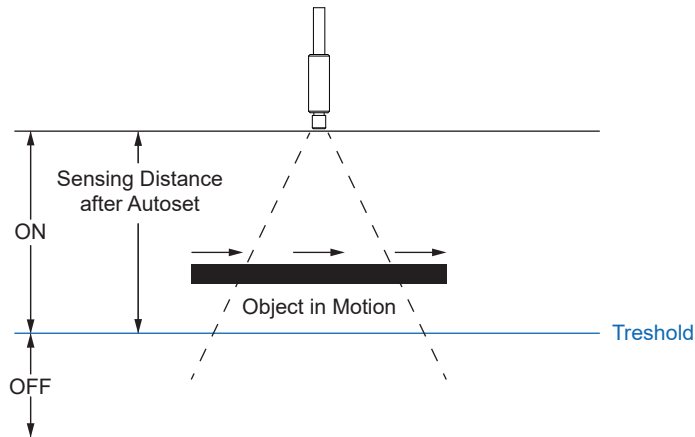

Following is a diagram of signal behavior in the different modes.

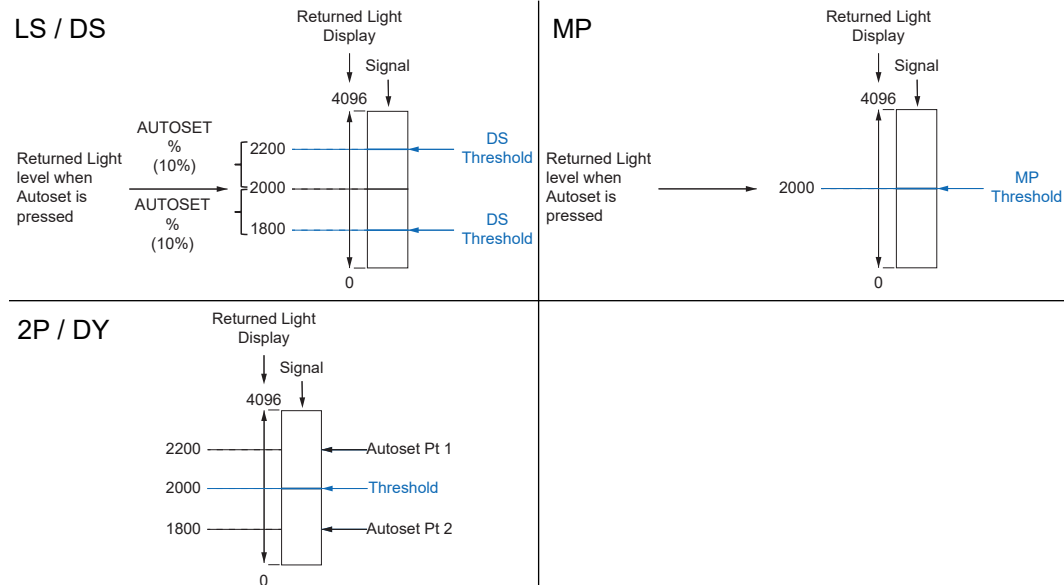

III. 2: Comparison of AUTOSET settings

For more detailed information on the following please refer to chapter [Annex \[ 34 \]](#).

**IO-Link access: AUTOSET**

Parameter &gt; Teach-in Single Value

Name	Index	Subindex	Description
Single Value Teach Mode	80	–	Single vaule teach mode. <ul style="list-style-type: none"> <li>Light State Teach (-AUTOSET Percent)</li> <li>Dark State Teach (+AUTOSET Percent)</li> <li>Midpoint Teach (+0)</li> </ul>
System Command	2	–	Teach SP1

Value *AUTOSET Percent* must be set in Parameter > Switching Signal Channel 1 (SSC1) > AUTOSET Percent.

Parameter &gt; Teach-in Two Value

Name	Index	Subindex	Description
System Command – Teach SP1 TP1	2	–	Teach SP1 TP1
System Command – Teach SP1 TP2	2	–	Teach SP1 TP2
System Command – Teach Apply	2	–	Apply teach process.
System Command – Teach Cancel	2	–	Cancel teach process.

Parameter &gt; Teach-in Dynamic

Name	Index	Subindex	Description
System Command – Teach SP1 Start	2	–	Start teach process.
System Command – Teach SP1 Stop	2	–	Stop teach process.
System Command – Teach Cancel	2	–	Cancel teach process.

**Display access: AUTOSET****Instruction:**

- Press **Mode** until **AUTOSET Mode** appears on the display.
- Use the selector +/- to set the required mode.
- Press **AUTOSET** to trigger the desired teaching process.

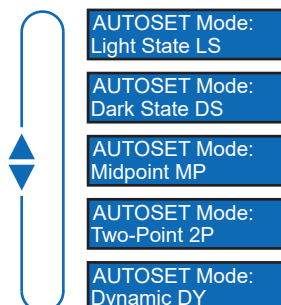

## 5.2 AUTOSET Percent

The offset percentages for the AUTOSET modes Light State (LS), Dark State (DS) and Window (WN) can be adjusted. This will set the switching point by AUTOSET mode and delivers the intensity of the received light beam as a percentage.

For more detailed information on the following please refer to chapter [Annex | 34](#).

### IO-Link access: AUTOSET Percent

Parameter > Switching Signal Channel 1 (SSC1)

Name	Index	Subindex	Description
AUTOSET Percent	69	–	Offset value for AUTOSET Modi LS, DS and WN. Allowed value: 1 ... 90 [%]

### Display access: AUTOSET Percent

#### **Instruction:**

- a) Press **Mode** until **AUTOSET Pct.** appears on the display.
- b) Set the required value with the selector +/- . To scroll, press and hold the button.
- c) Press **Mode** to select the setting.



### 5.3 Detect Mode

This function defines the sensor's switching logic.

- **Light ON (LO)** - Output is active when the light intensity of the received beam is above the defined switching point. In Window Modus (WN) is the output active when the intensity of the received light beam is within the defined switching limits.
- **Dark ON (DO)** - The output is not active if the light intensity of the received beam is above the defined switching point. In Window Modus (WN) is the output active when the intensity of the received light beam is outside the defined switching limits.

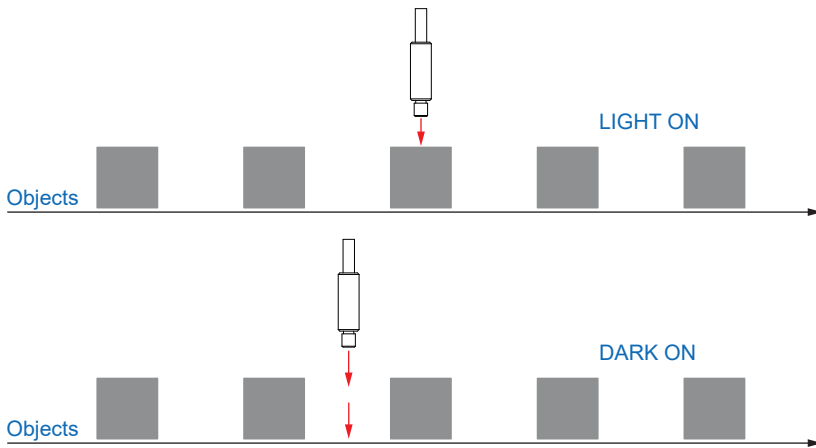

III. 3: Diagram of the LO/DO switching logics

For more detailed information on the following please refer to chapter [Annex \[▶ 34\]](#).

#### IO-Link access: Detect mode

Parameter > Switching Signal Channel 1 (SSC1)

Name	Index	Subindex	Description
SSC1 Config – Logic	57	–	Defines the logical behaviour of the switching signal and derived output signal. <ul style="list-style-type: none"> <li>▪ LO - Light On - High Active</li> <li>▪ DO - Dark On - Low Active</li> </ul>

#### Display access: Detect Mode

##### Instruction:

- a) Press **Mode** until **Detect Mode** appears on the display.
- b) Make the required setting by help of the selector +/-.
- c) Press **Mode** to select the setting.

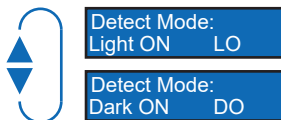



## 5.4 Response Time

This function is to define the response time delivering the optimum results in the respective application.

Select the best performance for the respective application in *Response Time*. Sensor speed, range and sensitivity are optimized for the best performance.

Fastest Speed	Ultra-High-Speed
	High-Speed
	Standard
	High-Resolution
	Long-Range
	Longest Range

Parameter	Abbreviation / Term	Description
Ultra-High-Speed	UHS	Shortest response time (50us) Not available in asynchronous anti-crosstalk mode.
High-Speed	HS	Short response time (120 us) Not available in asynchronous anti-crosstalk mode.
Standard	STD	Good balance between response time and overall detection (250 us)
High-Resolution	HR	Improved resolution for general applications (1ms)
Long-Range	LR	General application with extended range (4ms)
Ultra-Long-Range	ULR	Special application with maximum range and sensitivity (16ms)

For more detailed information on the following please refer to chapter [Annex ▸ 34](#).

### IO-Link access: Response time

Parameter > Switching Signal Channel 1 (SSC1)

Name	Index	Subindex	Description
Response Time	64	–	Response time. <ul style="list-style-type: none"> <li>▪ UHS - Ultra-High-Speed</li> <li>▪ HS - High-Speed</li> <li>▪ STD - Standard</li> <li>▪ HR - High-Resolution</li> <li>▪ LR - Long-Range</li> <li>▪ ULR - Ultra-Long-Range</li> </ul>

**Display access: Response time****Instruction:**

- a) Press **Mode** until **Response Time** appears on the display.
- b) Make the required setting by help of the selector +/-.
- c) Press **Mode** to select the setting.

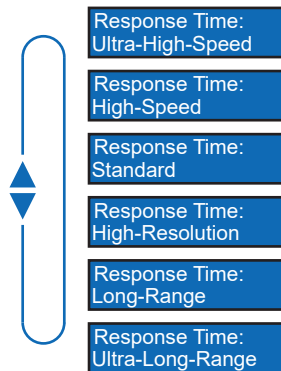
**5.5 Hysteresis**

This function prevents unwanted switching operations by the switching output. The parameterized value of the hysteresis is the difference in distance between the points at which the switching output is activated and deactivated. Baumer recommends always setting the hysteresis not equal to 0.

Hysteresis is the difference between switching point and reset point. The following diagram shows the function principle:

- Light blue: object moving from far to near (here switching point)
- Dark blue: object moving from near to far (here reset point)

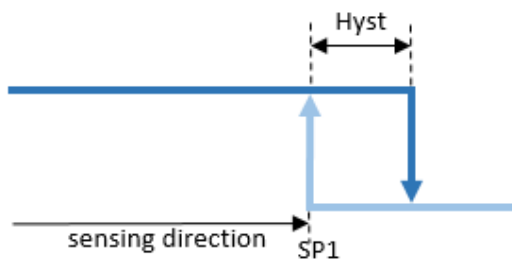
**III. 4: Hysteresis**

Hysteresis is specified in percent, i.e. in relation to the set switching distance.

**Hysteresis alignment**

Axial detection tasks such as stop trigger or point level detection require accurate switching distance. To align switching behavior and hysteresis to the object's moving direction, the hysteresis orientation be modified.

This function is only active in *Single Point* or *Window* mode.

*Left Aligned (negative hysteresis):*

Hysteresis is aligned either to or against the sensing direction.

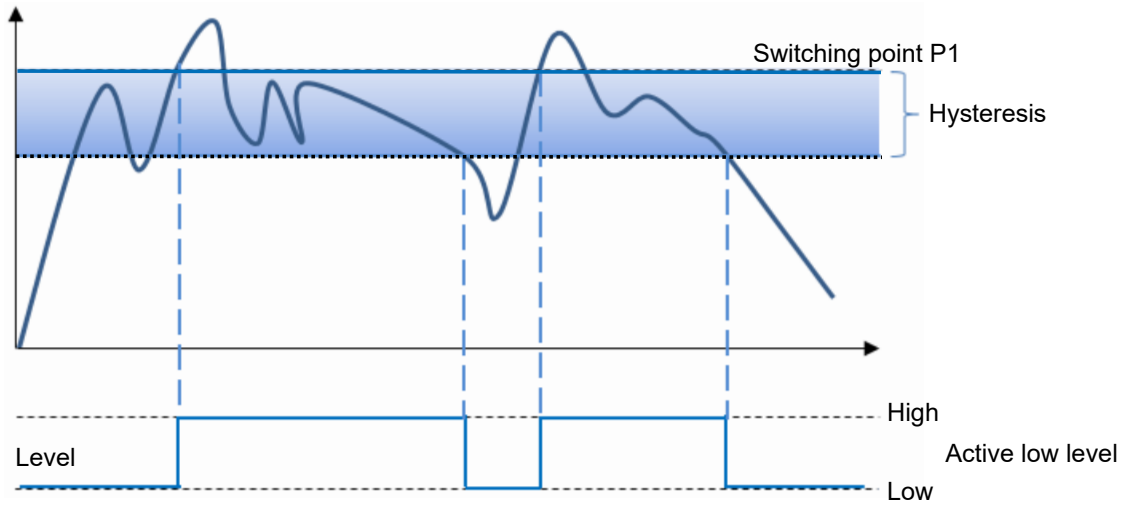

III. 5: Switching output behavior in mode *Single Point* and negative hysteresis (*Left Aligned*)

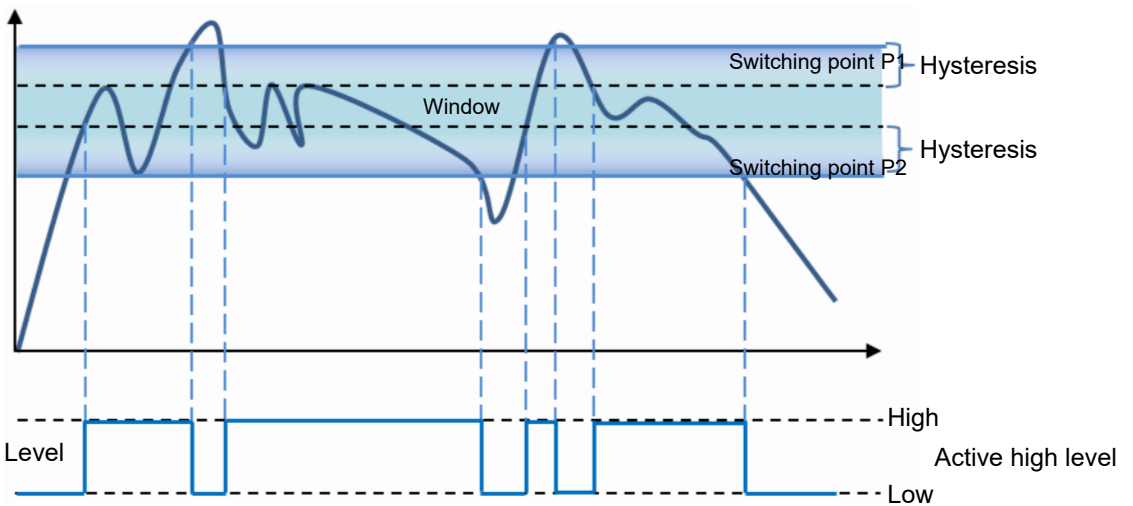

III. 6: Switching output behavior in mode *Window* and negative hysteresis (*Left Aligned*)

*Right Aligned (positive hysteresis):*

Hysteresis is aligned to or against the sensing direction.

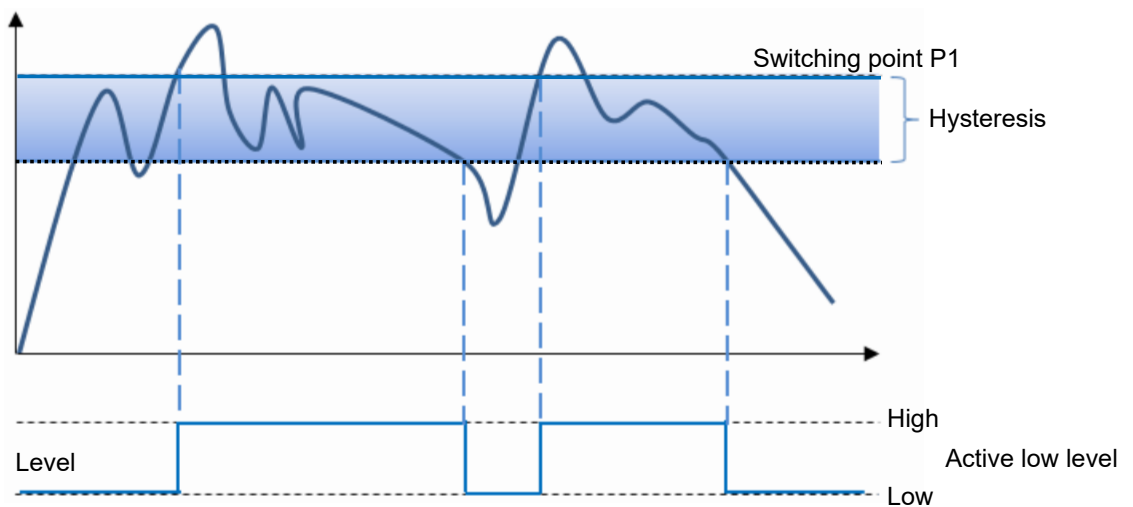

III. 7: Switching output behavior in mode *Single Point* and negative hysteresis (*Left Aligned*)

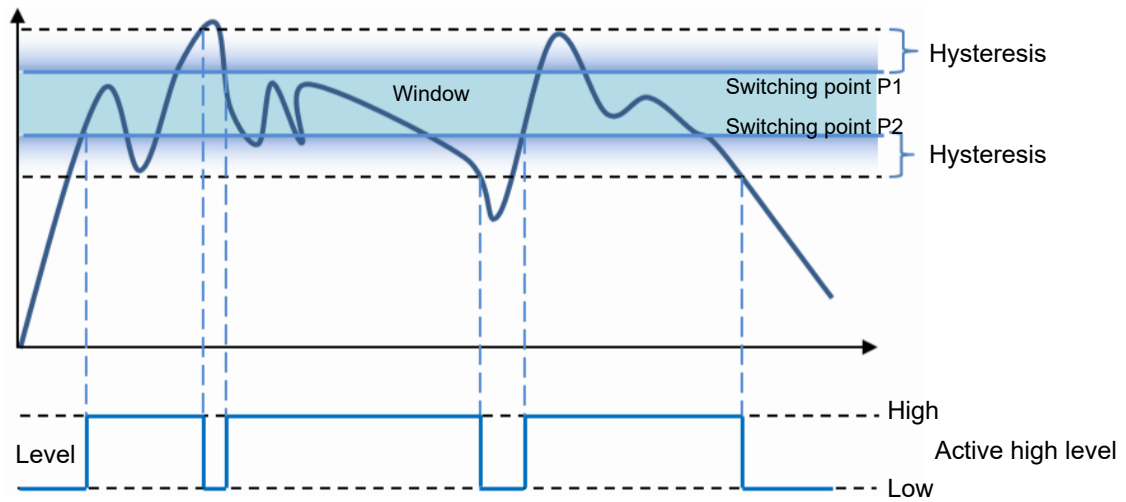

III. 8: Switching output behavior in mode *Window* and negative hysteresis (*Right Aligned*)

*Center Aligned:*

Compromise between positive and negative hysteresis. Hysteresis alignment is in symmetry to the individual target values.

For more detailed information on the following please refer to chapter [Annex \[▶ 34\]](#).

**IO-Link access: hysteresis**

Parameter > Switching Signal Channel 1 (SSC1)

Name	Index	Subindex	Description
Hysteresis	66	–	<ul style="list-style-type: none"> <li>■ H0 - Low</li> <li>■ H1 - Standard</li> <li>■ H2 - High</li> </ul>

**Display access: Hysteresis**

**Instruction:**

- a) Press **Mode** until **Hysteresis** appears on the display.
- b) Make the required setting by help of the selector +/-.
- c) Press **Mode** to select the setting.

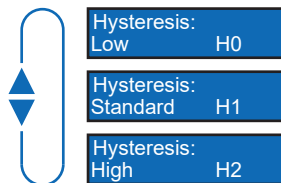

## 5.6 Anti-Crosstalk

Where having deployed two sensors close to each other, this function provides settings for anti-crosstalk channels. This prevents output of wrong signals in the event the sensors' fields of view should overlap.



### INFO

SSC1 and SSC2 cannot be defined as channels A and B.

The anti-crosstalk function is intended for use of two individual sensors.

This function is NOT available in UHS and HS mode.

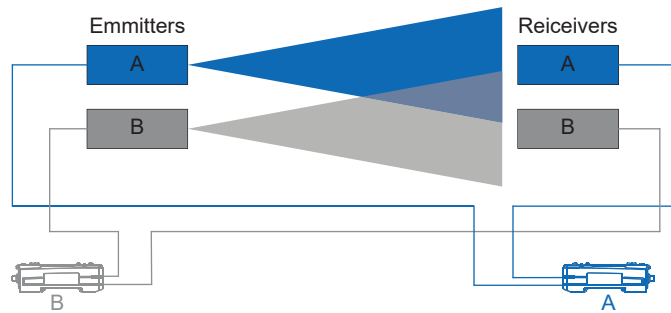

For more detailed information on the following please refer to chapter [Annex \[▶ 34\]](#).

### IO-Link access: Anti-crosstalk

Parameter > Switching Signal Channel 1 (SSC1)

Name	Index	Subindex	Description
Anti-Crosstalk	67	–	<ul style="list-style-type: none"> <li>▪ Disabled - Full Speed</li> <li>▪ xA - Channel A</li> <li>▪ xB - Channel B</li> </ul>

### Display access: Anti-Crosstalk

- a) Press **Mode** until **Anti-Crosstalk** appears on the display.
- b) Make the required setting by help of the selector +/-.
- c) Press **Mode** to select the setting.

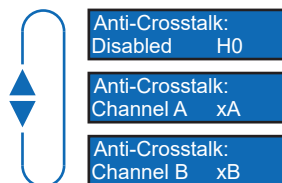

### 5.7 Timer/counter function

You can choose among 19 pre-configured timer/counter functions. Each one represents a function, e.g. switch-on delay, switch-off delay, etc. When having selected a function you are provided with the related programming parameters.

No.	Parameters	Signal curve
00	Bypass	
01	On-Delay	
02	Off-Delay	
03	One-Shot	
04	Motion	
06	On, Off-Delay	
07	On, One-Shot	

No.	Parameters	Signal curve
09	Off, One-Shot	<p>The diagram shows an input signal that transitions from ON to OFF. A vertical dashed line marks the event. The output signal shows a pulse that starts after a delay following the OFF event, labeled 'OFF One-Shot Delay'.</p>
11	Blind One-Shot	<p>The diagram shows an input signal with multiple pulses. The output signal shows pulses that occur after a delay following the OFF event, labeled 'One-Shot' and 'Blind'.</p>
12	Delayed One-Shot	<p>The diagram shows an input signal with multiple pulses. The output signal shows pulses that occur after a delay following the OFF event, labeled 'D OS' (Delay One-Shot).</p>
14	Stop, One-Shot	<p>The diagram shows an input signal with multiple pulses. The output signal shows a pulse that occurs after a delay following the OFF event, labeled 'Retriggerable One-Shot' and 'One-Shot'.</p>

For more detailed information on the following please refer to chapter [Annex \[▶ 34\]](#).

### IO-Link access: Timer function

Parameter > Switching Signal Channel 1 (SSC1)

Name	Index	Subindex	Description
Timer Function	70	–	Choose timer function. <ul style="list-style-type: none"> <li>■ 0: 00 - Bypass / None</li> <li>■ 1: 01 - T1: On-Delay</li> <li>■ 3: 02 - T1: Off-Delay</li> <li>■ 4: 03 - T1: One-Shot</li> <li>■ 5: 04 - T1: Motion</li> <li>■ 6: 06 - T1: On Delay, T2: Off Delay</li> <li>■ 7: 07 - T1: On Delay, T2: One-Shot</li> <li>■ 9: 09 - T1: Off Delay, T2: One-Shot</li> <li>■ 11: 11 - T1: Blind, T2: One-Shot</li> <li>■ 12: 12 - T1: Delay, T2: One-Shot</li> <li>■ 14: 14 - T1: Stop Motion, T2: One-Shot</li> </ul>
Timer 1	71	–	Timer 1 [ms]
Timer 2	72	–	Timer 2 [ms]

**Display access: Timer Function****Instruction:**

- a) Press **Mode** until **Timer Func** appears on the display.
- b) Make the required setting by help of the selector +/- (e.g. On-Delay).

+ ▲ TimerFunc: 01  
- ▼ On-Delay

- c) Press **Mode** to select the setting.

- ✓ According to the selected settings you may be provided with more options for the function (e.g. **OnDelay**).

+ ▲ On Delay:  
- ▼ 10ms

Make choice using the selector +/- and confirm each setting with **Mode**.



## 5.8 Q2 IO function

This is to adjust the Q2 line functionality. The Q2 line (white stranded wire) can be configured either as output or external AUTOSET input.

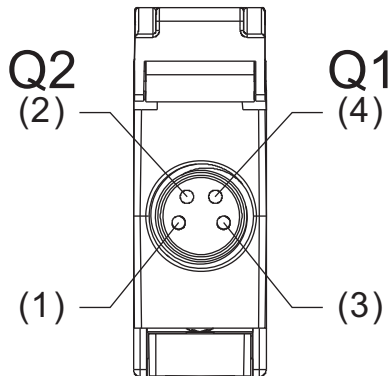

Parameter	Description
Disabled	Unwanted signals will be ignored.
Output – PNP – Source	Q2 is set to <i>Output PNP Source</i> (open collector output (OC)).
Output – NPN – Sink	Q2 is set to <i>Output NPN Sink</i> (open collector output (OC)).
Output – Push/Pull	Q2 is set to <i>Output Push/Pull</i> (open collector output (OC)). <b>Note:</b> NPN and PNP transistors are interconnected in a push-pull configuration.
Remote Set – Active High	A AUTOSET function is executed when the Q2 line switches from the idle state to the active state and returns. <b>Note:</b> Further to AUTOSET you may use the input line.
Remote Set – Active Low	The Q2 line changing from active to idle state and back will execute an AUTOSET operation. <b>Note:</b> Further to AUTOSET you may use the input line.
Remote Lock – Active High	Remote access to AUTOSET, selector +/- and most mode functions is blocked if the input is active.
Remote Lock – Active Low	Remote access to AUTOSET, selector +/- and most mode functions is blocked if the input is inactive.

For more detailed information on the following please refer to chapter [Annex \[▶ 34\]](#).

### IO-Link access: Input function

Parameter > Interface Parameters

Name	Index	Subindex	Description
Q2 Function	73	–	Function for line Q2. <ul style="list-style-type: none"> <li>■ Disabled</li> <li>■ Output – PNP – Source</li> <li>■ Output – NPN – Sink</li> <li>■ Output – Push/Pull</li> <li>■ Remote Set – Active High</li> <li>■ Remote Set – Active Low</li> <li>■ Remote Lock – Active High</li> <li>■ Remote Lock – Active Low</li> </ul>

### Display access: Input function

#### **Instruction:**

- a) Press **Mode** until **Q2** appears on the display.
- b) Make the required setting by help of the selector +/-.
- c) Press **Mode** to select the setting.

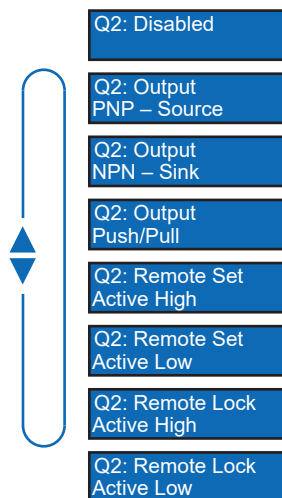

## 5.9 MDC configuration

This defines which measured value is mapped to the MDC channel and therefore available via the process data path *Process Data In (PDI)*. Cyclic communication.

Select:

- Signal level
- Quality level
- Number of switching operations detected by channel

For more detailed information on the following please refer to chapter [Annex ▶ 34](#).

### IO-Link access: Input function

Parameter > MDC Configuration

Name	Index	Subindex	Description
MDC Selection	81	—	MDC selection source. <ul style="list-style-type: none"> <li>▪ SCC1 Signal Level</li> <li>▪ SCC1 Quality Value</li> <li>▪ SCC1 Switch count</li> </ul>
Lower Value	16512	1	Shows the lower value of measurement range.
Upper Value	16512	2	Shows the upper value of measurement range.
Unit Code	16512	3	Shows the unique code for the physical unit.
Scale	16512	4	Shows the multiplier for the measurement value - $10^{\text{exp}(\text{scale})}$ .

## 5.10 Display-Mode

Use this function to shift the display orientation by 180°. You can also select the display to provide a numerical value or percentage.

For more detailed information on the following please refer to chapter [Annex \[▶ 34\]](#).

### IO-Link access: Display mode

Parameter > Interface Parameters

Name	Index	Subindex	Description
Display Mode	74	–	<ul style="list-style-type: none"> <li>■ 0 = Standard</li> <li>■ 1 = Inverted</li> <li>■ 2 = Standard %</li> <li>■ 3 = Inverted %</li> </ul>

### Display access: Display mode

#### Instruction:

- a) Press **Mode** until **Display Mode** appears on the display.
- b) Make the required setting by help of the selector +/-.
- c) Press **Mode** to select the setting.

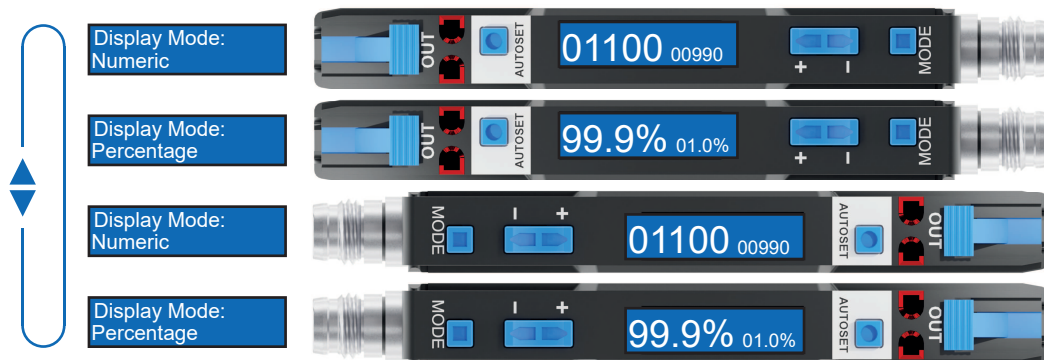

## 5.11 Lock-Mode

Lock mode will block every button.

- *Enabled*
  - In lock mode, all buttons are locked to prevent unintended access for effective access control.
  - However, please note, that the input line remains unblocked.
- *Disabled*
  - Buttons are enabled and will react to standard input prompts.

For more detailed information on the following please refer to chapter [Annex \[▶ 34\]](#).

### IO-Link access: Lock mode

Parameter > Interface Parameters

Name	Index	Subindex	Description
Settings - Button Interface	75	–	Choose setting: <ul style="list-style-type: none"> <li>▪ 0: Unlocked</li> <li>▪ 1: Locked</li> <li>▪ 3: Secured</li> </ul>
Lock Mode	77	–	Choose setting: <ul style="list-style-type: none"> <li>▪ 0: Standard Read-Only</li> <li>▪ 1: Allow Set/Teach</li> <li>▪ 3: Allow Set and Adjust</li> </ul>

### Display access: Lock mode

#### **Instruction:**

- a) Press **Mode** until **Button Lock** appears on the display.
- b) Make the required setting by help of the selector +/-.
- c) Press **Mode** to select the setting.

#### **Result:**

- ✓ The display shows **Sensor Locked** if lock mode is active.



## 5.12 Factory settings

This function restores default in the entire sensor values and parameterization. Default will be restored in the entire user settings.

You have the following options:

Designation	Description
Application Reset	Restores default in the parameterization of the technology-specific application. Identification parameters will be retained. If enabled, an upload to the data memory of the master is executed.
Restore Factory Settings	Restores default in all device parameters. Note: A download of the data memory can be executed at next device power on to overwrite the default settings.
Back-to-box	Restores default in all device parameters and communication is blocked until next power on of the device. Note: Disconnect device straight at the master port.

### Overview on default settings

Function	Factory settings
AUTOSET Button Mode	Light-State
AUTOSET Percent	10%
DETECT Mode	Light On
Response Time	Standard
Hysteresis	Standard
Anti-Crosstalk	Disabled
Timer	Bypass
Timer Duration	10ms
Input Functions	Disabled
Display Mode	Numeric
Lock Mode	Disabled

For more detailed information on the following please refer to chapter [Annex \[▶ 34\]](#).

#### IO-Link access: factory settings

Name	Index	Subindex	Description
System Command	2	–	<ul style="list-style-type: none"><li>■ 129 = Application Reset</li><li>■ 130 = Restore Factory Settings</li><li>■ 131 = Back-to-box</li></ul>

#### Display access: Factory settings

##### **Instruction:**

- a) Press and hold **Mode** while connecting the sensor.
  - ✓ The display will give visual feedback.
- b) Confirm with selector +/-.

##### **Result:**

- ✓ Default settings have been restored.

## 6 Diagnostic functions

### 6.1 Signal strength

This function outputs the signal quality.

The signal strength of an optical sensor refers to the intensity of the electrical or electronic signals generated by the sensor in response to light.

For more detailed information on the following please refer to chapter [Annex \[▶ 34\]](#).

#### IO-Link access: Signal quality

Name	Index	Subindex	Description
Signal Level	128	–	Signal Level

### 6.2 Switching point

This function is used to output the switching point.

The switching point is set using the *AUTOSET* function and adjusted where required using the selector +/- . The sensor executes a switching operation as soon as the amount of light measured is exceeding the switching point. If the measured value is inferior to the switching point there will be no switching operation.

For more detailed information on the following please refer to chapter [Annex \[▶ 34\]](#).

#### IO-Link access: switching point

Name	Index	Subindex	Description
Threshold	129	–	Threshold

### 6.3 Device status

This function is for retrieving information on the device status.

For more detailed information on the following please refer to chapter [Annex \[▶ 34\]](#).

#### IO-Link access: Device status

Name	Index	Subindex	Description
Device Status	36	–	Indicator for the current device condition and diagnosis state. <ul style="list-style-type: none"> <li>■ 0 – Device is OK</li> <li>■ 1 – Maintenance required</li> <li>■ 2 – Out of specification</li> <li>■ 3 – Functional check</li> <li>■ 4 – Failure</li> </ul>
Detailed Device Status	37	1	–



## 6.4 Identification

These functions read or write sensor identification information.

For more detailed information on the following please refer to chapter [Annex ▸ 34](#).

### IO-Link access: Identification

Name	Index	Subindex	Description
Vendor Name	16	–	The vendor name that is assigned to a Vendor ID. Default value: Baumer Electric AG
Vendor Text	17	–	Additional information about the vendor. Default value: www.baumer.com
Product Name	18	–	Complete product name.
Product ID	19	–	Vendor-specific product or type identification (e.g. item number or model number).
Product Text	20	–	Additional product information for the device.
Application-specific Tag	24	–	Possibility to mark a device with user- or application-specific information.
Function Tag	25	–	User specified function tag.
Location Tag	26	–	User specified location tag.
Serial Number	21	–	Unique, vendor-specific identifier of the individual device.
Firmware Revision	23	–	Unique, vendor-specific identifier of the firmware revision of the individual device.
Hardware Revision	22	–	Unique, vendor-specific identifier of the hardware revision of the individual device.

## 7 Annex

### 7.1 IO-Link

#### 7.1.1 PDI

subindex	bit offset	data type	allowed values	default value	acc. restr.	mod. other var.	excl. from DS	name	description
1	16	16-bit Integer						Measurement Value	
2	8	8-bit Integer						Scale	
8	2	Boolean						SSC1/Quality	
10	0	Boolean						SSC1/Signal Level	

##### Octet 0

bit offset	31	30	29	28	27	26	25	24
subindex	1							
element bit	15	14	13	12	11	10	9	8

##### Octet 1

bit offset	23	22	21	20	19	18	17	16
subindex	1							
element bit	7	6	5	4	3	2	1	0

##### Octet 2

bit offset	15	14	13	12	11	10	9	8
subindex	2							
element bit	7	6	5	4	3	2	1	0

##### Octet 3

bit offset	7	6	5	4	3	2	1	0
subindex	/////	/////	/////	/////	/////	8	/////	10

### 7.1.2 Identification

Index	Subindex	Name	Data type	Access rights	Value range	Description
16	0	Vendor Name	String	R	ASCII	Vendor name that is assigned to a vendor ID, e. g. Baumer.
17	0	Vendor Text	String	R	ASCII	Additional information about the vendor, e. g. www.baumer.com
18	0	Product Name	String	R	ASCII	Complete product name, e. g. IFxx.DxxL.
19	0	Product ID	String	R	ASCII	Vendor-specific product or type identification, e. g. item number or model number.
20	0	Product Text	String	R	ASCII	Additional product information for the device.
21	0	Serial number	String	R	ASCII	Unique, vendor-specific identifier of the individual device.
22	0	Hardware revision	String	R	ASCII	Unique, vendor-specific identifier of the hardware revision of the individual device, e. g. 00.00.01
23	0	Firmware Revision	String	R	ASCII	Unique, vendor-specific identifier of the firmware revision of the individual device, e .g. 00.00.04
24	0	Application specific Tag	String	R/W	ASCII	Possibility to mark a device with user-or application-specific information.
25	0	Function Tag	String	R/W	ASCII	Possibility to mark a device with function-specific information.
26	0	Location Tag	String	R/W	ASCII	Possibility to mark a device with location-specific information.

### 7.1.3 Parameter

#### 7.1.3.1 Switching Signal Channel 1 (SSC1)

Index	Subindex	Name	Data type	Access rights	Value range	Description
56	–	SSC1 Param - SP	Uint16	R/W	1 ... 32767	Sensitivity or setpoint values for switching signal channel.
57	–	SSC1 Config - Logic	Uint8	R/W		Defines the logical behaviour of the switching signal and derived output signal. <ul style="list-style-type: none"> <li>▪ LO - Light On - High Active</li> <li>▪ DO - Dark On - Low Active</li> </ul>
69	–	AUTOSET Percent	Uint8	R/W	1 ... 90	AUTOSET Percent

Index	Subindex	Name	Data type	Access rights	Value range	Description
70	–	Timer Function	Uint16	R/W		Choose timer function. <ul style="list-style-type: none"> <li>■ 0: 00 - Bypass / None</li> <li>■ 1: 01 - T1: On-Delay</li> <li>■ 3: 02 - T1: Off-Delay</li> <li>■ 4: 03 - T1: One-Shot</li> <li>■ 5: 04 - T1: Motion</li> <li>■ 6: 06 - T1: On Delay, T2: Off Delay</li> <li>■ 7: 07 - T1: On Delay, T2: One-Shot</li> <li>■ 9: 09 - T1: Off Delay, T2: One-Shot</li> <li>■ 11: 11 - T1: Blind, T2: One-Shot</li> <li>■ 12: 12 - T1: Delay, T2: One-Shot</li> <li>■ 14: 14 - T1: Stop Motion, T2: One-Shot</li> </ul>
71	–	Timer 1	Uint32	R/W	0.1 ... 9999.9	Timer 1 [ms]
72	–	Timer 2	Uint32	R/W	9999.9 ... 0.1	Timer 2 [ms]
64	–	Response Time	Uint16	R/W		Response time. <ul style="list-style-type: none"> <li>■ 1: UHS - Ultra-High-Speed</li> <li>■ 2: HS - High-Speed</li> <li>■ 3: STD - Standard</li> <li>■ 4: HR - High-Resolution</li> <li>■ 5: LR - Long-Range</li> <li>■ 6: ULR - Ultra-Long-Range</li> </ul>
65	–	LED Power	Uint16	R/W		LED Power. <ul style="list-style-type: none"> <li>■ 12: A0 - Low - Automatic</li> <li>■ 13: A1 - High - Automatic</li> <li>■ 14: P0 - Low - Fixed</li> <li>■ 15: P1 - High - Fixed</li> </ul>

Index	Subindex	Name	Data type	Access rights	Value range	Description
66	–	Hysteresis	Uint16	R/W		<ul style="list-style-type: none"><li>0: H0 - Low</li><li>1: H1 - Standard</li><li>2: H2 - High</li></ul>
67	–	Anti-Crosstalk	Uint16	R/W		<ul style="list-style-type: none"><li>0: Disabled - Full Speed</li><li>1: xA - Channel A</li><li>2: xB - Channel B</li></ul>

## 7.1.3.2 Teach-in

Index	Subindex	Name	Data type	Access rights	Value range	Description
<b>Teach-in Single Value</b>						
2	–	System Command - Teach SP1	UInt8	W		<ul style="list-style-type: none"> <li>68 = Teach SP1</li> </ul>
80	–	Single Value Teach Mode	UInt16	R/W		<ul style="list-style-type: none"> <li>0 = Light State Teach (-AUTOSET Percent)</li> <li>1 = Dark State Teach (+AUTOSET Percent)</li> <li>2 = Midpoint Teach (+0)</li> </ul>
59	1	State	UInt4	R		<ul style="list-style-type: none"> <li>0 = Idle</li> <li>1 = Success</li> <li>4 = Wait for command</li> <li>5 = Busy</li> <li>7 = Error</li> </ul>
<b>Teach-in Two Value</b>						
2	–	System Command - Teach SP1 TP1	UInt8	W		<ul style="list-style-type: none"> <li>67 = Teach SP1 TP1</li> </ul>
2	–	System Command - Teach SP1 TP2	UInt8	W		<ul style="list-style-type: none"> <li>68 = Teach SP1 TP2</li> </ul>
2	–	System Command - Teach Apply	UInt8	W		<ul style="list-style-type: none"> <li>64 = Teach Apply</li> </ul>
2	–	System Command - Teach Cancel	UInt8	W		<ul style="list-style-type: none"> <li>79 = Teach Cancel</li> </ul>
59	1	State	UInt4	R		<ul style="list-style-type: none"> <li>0 = Idle</li> <li>1 = Success</li> <li>4 = Wait for command</li> <li>5 = Busy</li> <li>7 = Error</li> </ul>
59	2	Flag SP1 TP1	Boolean	R		<ul style="list-style-type: none"> <li>false = Initial or not ok</li> </ul>
59	3	Flag SP1 TP2	Boolean	R		<ul style="list-style-type: none"> <li>true = OK</li> </ul>

Index	Subindex	Name	Data type	Access rights	Value range	Description
<b>Teach-in Dynamic</b>						
2	–	System Command - Teach SP1 Start	UInt8	W		<ul style="list-style-type: none"> <li>71 = Teach SP1 Start</li> </ul>
2	–	System Command - Teach SP1 Stop	UInt8	W		<ul style="list-style-type: none"> <li>72 = Teach SP1 Stop</li> </ul>
2	–	System Command - Teach Cancel	UInt8	W		<ul style="list-style-type: none"> <li>79 = Teach Cancel</li> </ul>
59	1	State	UInt4	R		<ul style="list-style-type: none"> <li>0 = Idle</li> <li>1 = Success</li> <li>4 = Wait for command</li> <li>5 = Busy</li> <li>7 = Error</li> </ul>

### 7.1.3.3 SwitchCounts

Index	Subindex	Name	Data type	Access rights	Value range	Description
1000	–	Baumer Commands - SSC1 Switch Counts Reset	UInt8	W		12 = SSC1 Switch Counts Reset
144	–	Switch Counts SSC1 Resettable	UInt32	R		SSC1 Resettable Switch Counts

### 7.1.3.4 Quality Parameters

Index	Subindex	Name	Data type	Access rights	Value range	Description
83	–	Quality Value	UInt16	R	65535 ... 0	Quality value settings. Represents the excess gain ratio in [%].
82	–	Quality Bit Threshold	UInt16	R/W	65535 ... 0	Sets the threshold for the quality bit which is mapped to the input process data and used for the LED weak signal indication.

### 7.1.3.5 MDC Configuration

Index	Subindex	Name	Data type	Access rights	Value range	Description
81	–	MDC Selection	Uint8	R/W		MDC selection source. <ul style="list-style-type: none"> <li>■ SCC1 Signal Level</li> <li>■ SCC1 Quality Value</li> <li>■ SCC1 Switch count</li> </ul>
16512	1	Lower Value	Uint16	R/W		Shows the lower value of measurement range.
16512	2	Upper Value	Uint32	R/W		Shows the upper value of measurement range.
16512	3	Unit Code	Uint8	R		Shows the unique code for the physical unit.
16512	4	Scale	Uint16	R/W		Shows the multiplier for the measurement value - 10exp(scale).

### 7.1.3.6 Interface Parameters

Index	Subindex	Name	Data type	Access rights	Value range	Description
68	–	AUTOSET Button Mode	Uint8	R/W		<ul style="list-style-type: none"> <li>■ 0 = LS - Light State (-AUTOSET Percent)</li> <li>■ 1 = DS - Dark State (+AUTOSET Percent)</li> <li>■ 2 = MP - Midpoint (+0)</li> <li>■ 3 = 2P - Two Point (Average of Two Points)</li> <li>■ 4 = DY - Dynamic (Average of Min/Max)</li> </ul>
73	–	Q2 Function	Uint16	R/W		Function for line Q2. <ul style="list-style-type: none"> <li>■ Disabled</li> <li>■ Output – PNP – Source</li> <li>■ Output – NPN – Sink</li> <li>■ Output – Push/Pull</li> <li>■ Remote Set – Active High</li> <li>■ Remote Set – Active Low</li> <li>■ Remote Lock – Active High</li> <li>■ Remote Lock – Active Low</li> </ul>



Index	Subindex	Name	Data type	Access rights	Value range	Description
74	–	Display Mode	UInt16	R/W		<ul style="list-style-type: none"> <li>■ 0 = Standard</li> <li>■ 1 = Inverted</li> <li>■ 2 = Standard %</li> <li>■ 3 = Inverted %</li> </ul>
75	–	Settings - Button Interface	UInt16	R		<ul style="list-style-type: none"> <li>■ 0 = Unlocked</li> <li>■ 1 = Locked</li> <li>■ 2 = Secured</li> </ul>
76	–	Display	UInt16	R/W		<ul style="list-style-type: none"> <li>■ 0 = Always On</li> <li>■ 1 = Auto (5 min)</li> </ul>
77	–	Lock Mode	UInt16	R/W		<ul style="list-style-type: none"> <li>■ 0 = Standard Read-Only</li> <li>■ 1 = Allow Set/Teach</li> <li>■ 3 = Allow Set and Adjust</li> </ul>

#### 7.1.4 Diagnosis

##### 7.1.4.1 Factory Diagnostics

Index	Subindex	Name	Data type	Access rights	Value range	Description
128	–	Signal Level	UInt16	R		Signal level.
129	–	Threshold	UInt16	R		Threshold

##### 7.1.4.2 Device Status Information

Index	Subindex	Name	Data type	Access rights	Value range	Description
36	-	Device Status	UInt8	R		Indicator for the current device condition and diagnosis state. <ul style="list-style-type: none"> <li>■ 0 = Device is OK</li> <li>■ 1 = Maintenance required</li> <li>■ 2 = Out of specification</li> <li>■ 4 = Failure</li> </ul>
37	2	Detailed Device Status	Array	R		List of all currently pending events in the device.

### 7.1.4.3 Service Functions

Index	Subindex	Name	Data type	Access rights	Value range	Description
2	-	System Command	UInt8	W		<ul style="list-style-type: none"><li>■ 129 = Application Reset</li><li>■ 130 = Restore Factory Settings</li><li>■ 131 = Back-to-box</li></ul>



