



Description of functions and interfaces

IO-Link functions
OT300.SL, OT300.GL

EN-US

Table of contents

1	About this document	5
1.1	Purpose and scope of application	5
1.2	Applicable documents	5
1.3	Labels in this manual	5
1.4	Warnings in this manual	6
2	General functionality.....	7
2.1	Time of Flight (runtime measurement)	7
3	Interfaces	8
3.1	IO-Link.....	8
3.2	qTeach	9
4	Process data	10
5	Operating functions	12
5.1	System Commands.....	12
5.2	Measurement Values	13
5.2.1	Switch Counts	13
5.3	MDC Configuration.....	13
5.3.1	MDC descriptor	13
5.3.2	MDC source	14
5.4	SSC1 configuration	14
5.4.1	Time filter	15
5.5	SSC2 configuration	18
5.5.1	Time filter	19
5.6	SSC4 configuration	20
5.6.1	Time filter	21
5.7	Hysteresis	22
5.8	Teaching	23
5.8.1	Teach Point Offset	27
5.8.2	Teach Single Value.....	27
5.8.3	Teach Two Value (OT300.GL only)	28
5.8.4	Dynamic teaching	29
5.9	Signal Processing	30
5.10	Temperature Settings.....	31
5.10.1	Temperature	31
5.11	Input/Output Settings	32
5.12	Local user interface.....	36
5.12.1	Local Teach Mode	36
5.12.2	qTeach lock.....	37
5.12.3	LED Mode	38
5.13	Quality Value.....	39
5.14	Device Access Locks	39

5.15	Factory settings.....	40
6	Diagnostic functions.....	43
6.1	Device temperature.....	43
6.2	Operating hours.....	43
6.3	Device status.....	44
6.4	Histogram.....	44
6.5	Identification.....	47
7	Annex.....	48
7.1	IO-Link.....	48
7.1.1	PDI.....	48
7.1.2	PDO.....	48
7.1.3	Identification.....	49
7.1.4	Parameter.....	50
7.1.4.1	System Command.....	50
7.1.4.2	Measurement Values.....	50
7.1.4.2.1	SwitchCounts.....	50
7.1.4.3	MDC Configuration.....	51
7.1.4.4	SSCx Configuration.....	52
7.1.4.5	Teach.....	55
7.1.4.6	Signal Processing.....	58
7.1.4.7	Temperature Settings.....	59
7.1.4.8	Input/Output Settings.....	59
7.1.4.9	Local User Interface.....	60
7.1.4.10	Quality Parameters.....	61
7.1.4.11	Device Access Locks.....	61
7.1.5	Diagnosis.....	62
7.1.5.1	Device Status.....	62
7.1.5.2	Device Temperature.....	62
7.1.5.3	Power Supply.....	63
7.1.5.4	Operation Time.....	63
7.1.5.5	Histogram.....	64
7.2	<i>qTeach</i> [®]	66
7.2.1	Teach level overview.....	66

List of illustrations

III. 1	IO-Link architecture.....	8
III. 2	<i>Response Delay</i>	15
III. 3	<i>Release Delay</i>	16
III. 4	<i>Minimum Pulse Duration</i>	16
III. 5	SSC4/Counter behavior: Single Point or Window, Autoreset enabled or disabled	21
III. 6	Hysteresis in window mode.....	22
III. 7	Signal processing chain (diagram).....	30
III. 8	Circuit diagram of PNP switching output.....	32
III. 9	Circuit diagram of NPN switching output.....	32
III. 10	Circuit diagram of push-pull switching output.....	32
III. 11	Histogram of the device temperature (lifetime), example.....	45

1 About this document

1.1 Purpose and scope of application

This manual enables safe and efficient sensor parameterization. The manual describes the functions and is intended to support sensor installation and use.

The illustrations are examples only. Deviations are at the discretion of Baumer at all times. This manual is a supplement to the existing product documentation.

1.2 Applicable documents



- Available for download at www.baumer.com:
 - Functional and interface description
 - IODD
 - Data sheet
 - EU Declaration of Conformity
- Attached to product:
 - Quickstart
 - General information sheet (11042373)

1.3 Labels in this manual

Identifier	Usage	Example
<i>Dialog element</i>	Indicates dialog elements.	Click OK .
<i>Unique name</i>	Indicates the names of products, files, etc.	<i>Internet Explorer</i> is not supported in any version.
Code	Indicates entries.	Enter the following IP address: 192.168.0.250

1.4 Warnings in this manual

Warnings draw attention to potential personal injury or material damage. The warnings in this manual indicate different hazard levels:

Symbol	Warning term	Explanation
	DANGER	Indicates an imminent potential danger with high risk of death or serious personal injury if not being avoided.
	WARNING	Indicates potential danger with medium risk of death or (serious) personal injury if not being avoided.
	CAUTION	Indicates a danger with low risk, which could lead to light or medium injury if not avoided.
	NOTE	Indicates a warning of material damage.
	INFO	Indicates practical information and tips that enable optimal use of the devices.

2 General functionality

2.1 Time of Flight (runtime measurement)

The time of flight measurement is a process for indirect distance measurement by measuring the amount of time that a signal requires to cover the measuring distance. This means, a package of signals by a transmitter reflects at the object and returns to a receiver. The sensor evaluates both runtime and/or phase shift and converts these values into the distance information.

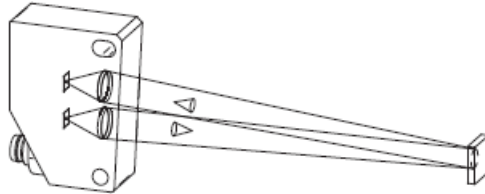

The time-of-flight technology ensures precise and reliable object detection over a long distance.

3 Interfaces

This section describes the available interfaces for operator to sensor communication.

3.1 IO-Link

IO-Link enables manufacturer-independent digital, bidirectional point-to-point communication. For this purpose, actuators or sensors are connected to an IO-Link master by standardized 3-wire connecting cables.

The IO-Link interface serves for parameterization of the sensor functions. In addition, measurement data and the function-generated sensor and status information are digitally transmitted in the form of process data to the machine controller (PLC). Secondary data informing on the machine condition allow for continuous process monitoring and process optimization.

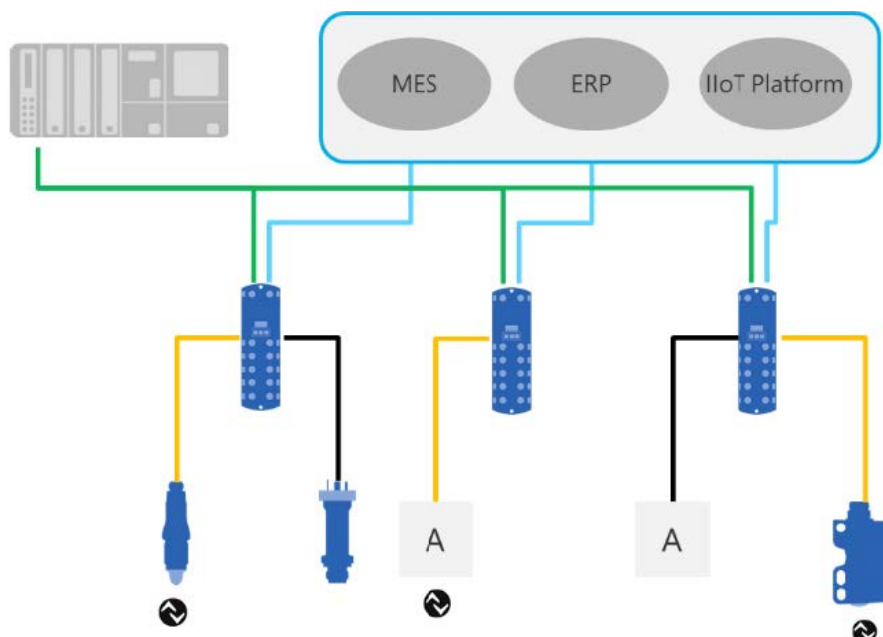

III. 1: IO-Link architecture

The IO-Link master clustering several sensors connects the controller via the respective fieldbus system, which is the so-called operational technology communication (OT communication). In addition, another Ethernet-based connection to the IO-Link master (e.g., via OPC UA or MQTT) enables direct communication between sensor and IT systems (IT communication).

There are two types of communication between IO-Link master and device.

- **Cyclic communication:**
transmission in real time - This data and information (process data) is used for process control in automation systems.
- **Acyclic communication:**
Time-uncritical communication for secondary data transmission or sensor parameterization.

To address both sensor functions and secondary data correctly, IO-Link interface description utilizes the so-called IODD (IO Device Description). IODD is available for download on the sensor website (download section). Digital sensor communication, secondary data and the option of direct sensor communication with the IT world makes IO-Link a cornerstone in Smart Factory.

**INFO**

For evaluation, parameterization and use of IO-Link sensors, Baumer provides both IO-Link USB-C master and Baumer Sensor Suite. The IO-Link USB-C Master enables IO-Link devices to communicate with the computer without external power supply. Baumer Sensor Suite is a computer-based tool to understand and use IO-Link devices and to visualize sensor functions of different sensor brands. This allows for engineering both at the workplace and straight at the machine. Further information at baumer.com/bss.

3.2**qTeach**

Some sensor functions enable parameterization via the Baumer *qTeach* feature. For parameterization using *qTeach*, simply touch the teaching field market at the sensor with a ferromagnetic tool.

During the parameterization operation, the sensor-integrated LED provides you with visual feedback.

Parameterization via *qTeach* is enabled in the factory settings and can be disabled via IO-Link.

**INFO**

Parameterization via teach is accessible for the first 5 minutes after sensor power on. This time having expired, *qTeach* is disabled. If *qTeach* is enabled within these first 5 minutes, *qTeach* will remain enabled for another 5 minutes. Editing the time window is using IO-Link.

4 Process data

If the sensor is in IO-Link communication mode, the process data is exchanged cyclically between the IO-Link master and the sensor (sensor<>IO-Link master). The IO-Link master needn't explicitly request the process data.

For more detailed information on the following please refer to chapter [Annex \[▶ 48\]](#).

Process Data In (PDI - Distance)

PDI is a 32-bit string and structured according to Smart Sensor Profile Definition *PDI32.INT16_INT8*.

Bit	Function	Description
0	SSC1	Switching Signal Channel 1 (Distance)
1	SSC2	Switching Signal Channel 2 (Distance)
2	Quality	This bit provides information about the quality of the light beam reflected by the object. <ul style="list-style-type: none"> ▪ Bit 2 = 0: The sensor signals suffice for reliable object detection. ▪ Bit 2 = 1: The sensor-detected reflection is crucial, it is recommended to check the sensor at the machine. The sensor might be misaligned or contaminated.
3	Alarm	The alarm bit indicates a problem identified in sensor configuration or function. <ul style="list-style-type: none"> ▪ Bit 3 = 0: Sensor is in standard operation. ▪ Bit 3 = 1: A problem in sensor configuration or function has been identified.
4	–	–
5	SSC4	Switching Signal Channel 4 (Counter) SSC4 configuration allows for binary signal setup in relation to the number of SSC1 or SSC2 switching operations. Integrated auto-reset and time filter enable setup of a full-featured batch counter for lot sizes without the need for any PLC software programming.
6 ... 15	–	–
16 ... 32	Measurement Data Channel (MDC)	Channel can be used read out the distance value or the switch numbers of SSC1, 2, 3 or 4 as a 16-bit integer value.

Tab. 1: Process Data In

Process Data Out (PDO)

Cyclic transmission of this data from IO-Link master to sensor.

Bit	Function	Description
0	Disable Laser	Changing this bit will disable the laser. This is to switch off the laser only, no electronics. The sensor will not provide any measured or switching value. This might be useful in sequential measuring operations with neighboring sensors. The command may shortly interrupt communication.
1	Find Me	Visualization, e.g. by flashing sensor LEDs for localization and physical sensor identification in machines or installations.

Tab. 2: Process Data Out

5 Operating functions

5.1 System Commands

Various system commands can be used to directly address the sensor.

For more detailed information on the following please refer to chapter [Annex \[▶ 48\]](#).

IO-Link access: System Commands

Name	Index	Subindex	Description
Device Reset (System Command)	2	–	Write value 128 to System Command. A warm start is triggered and the device is set to an initial state. Communication is interrupted by the device and then resumed by the master.
Application Reset (System Command)	2	–	Write value 129 to System Command. The parameters of the technology-specific application are set to default values. The identification parameters remain unchanged. An upload to the data memory of the master is carried out if this is activated in the port configuration of the master.
Restore Factory Settings (System Command)	2	–	Write value 130 to System Command. The device parameters are reset to the factory settings. Note: A download of the data memory can be carried out the next time the device is switched on and overwrite the factory settings!
Back-to-box (System Command)	2	–	Write value 131 to System Command. The device parameters are set to the factory default values. Communication is blocked until the next switch-on process. Note: Disconnect the device directly from the master connection.
Alignment Assistance (Baumer Command)	1000	–	Write value 255 to Baumer Command. Activate alignment assistance (increased laser brightness).

5.2 Measurement Values

This function is to output the current measured / count values.

For more detailed information on the following please refer to chapter [Annex \[▶ 48\]](#).

IO-Link access: Measurement Values

Name	Index	Subindex	Description
Distance	88	1	Returns the measured distance.
Counter Value	88	11	Returns the current counter value.

5.2.1 Switch Counts

This function is for independently zeroing each individual output counter.

For more detailed information on the following please refer to chapter [Annex \[▶ 48\]](#).

IO-Link access: Switch Counts Reset

Name	Index	Subindex	Description
SSC1 Switch Counts Reset (Baumer Commands)	1000	–	Write value 12 to Baumer Commands. Reset the SSC1 counter.
SSC2 Switch Counts Reset (Baumer Commands)	1000	–	Write value 13 to Baumer Commands. Reset the SSC2 counter.
SSC4 Switch Counts Reset (Baumer Commands)	1000	–	Write value 15 to Baumer Commands. Reset the SSC4 counter.

5.3 MDC Configuration

5.3.1 MDC descriptor

This function reads out the measuring range limits of the set MDC source. The sensor detecting a value out of range will report error *Out of range*(32760).

For more detailed information on the following please refer to chapter [Annex \[▶ 48\]](#).

IO-Link access: MDC source

Name	Index	Subindex	Description
Lower Limit	16512	1	Lower value of displayable process value range.
Upper Limit	16512	2	Upper value of displayable process value range.
Unit Code	16512	3	Unit code of the selected process value.
Scale	16512	4	Scale exponent x (10^x) of the selected process value.

5.3.2 MDC source

This function defines which measured value is mapped on the MDC channel and this way will be provided via process data path **Process Data In (PDI)** for cyclic communication. Selecting SSC1, SSC2 or SSC4 provides the number of switches recognized by the channel.

For more detailed information on the following please refer to chapter [Annex \[▶ 48\]](#).

IO-Link access: MDC source

Name	Index	Subindex	Description
Source	83	1	Possible values: <ul style="list-style-type: none"> ▪ Distance ▪ Frequency ▪ SSC1 Switch Counter ▪ SSC2 Switch Counter ▪ SSC4 Switch Counter

5.4 SSC1 configuration

This function is to set sensor switching point 1. Values within the range 450 to 2600 mm are permitted. Reaching the specified switching point 1 results in a sensor switching operation.

For more detailed information on the following please refer to chapter [Annex \[▶ 48\]](#).

Parameters *Config*

Defines the switching logic for switching point 1, distinguishing between logic, mode and hysteresis.

- Logic: Defines whether the output is active or inactive when reaching the switching point
- Mode: Defines the output mode. Options are "Single Point" and "Deactivated"
- Hysteresis: Defines the output hysteresis.

IO-Link access: SSC1 Configuration

Name	Index	Subindex	Description
Setpoints			
SP1	60	1	Defines the setpoint 1 value for the switching signal channel.
SP2	60	2	Defines the setpoint 2 value for the switching signal channel.
Config			
Logic	61	1	Defines the logical representation of the switching signal SSC in the process data. <ul style="list-style-type: none"> ▪ 0: High active ▪ 1: Low active
Mode	61	2	Defines the evaluation mode for the switching signal SSC. <ul style="list-style-type: none"> ▪ 0: Deactivated ▪ 1: Single point ▪ 2: Window ▪ 3: Two point

5.4.1 Time filter

This function defines whether there is a delay in output 1 release (Release Delay) or in output 1 response (Response Delay). Furthermore, parameters *Minimal Pulse Duration* and *Minimal Pulse Duration Mode* define pulse duration and behavior.

Response Delay

Response Delay specifies the time the measured value must exceed (Single Point Mode) or be within (Window Mode) the switching points of the assigned SSC until its status would change to active (or inactive in inverted logic).

Fields of application:

- Suppression of inferior peaks/ switching errors, e.g. caused by structural changes in the background.
- To prevent switching errors caused by known potential interference, e.g. by mixers.
- To avoid bouncing contacts.
- For optimized execute time of downstream actuators triggered by the sensor output.

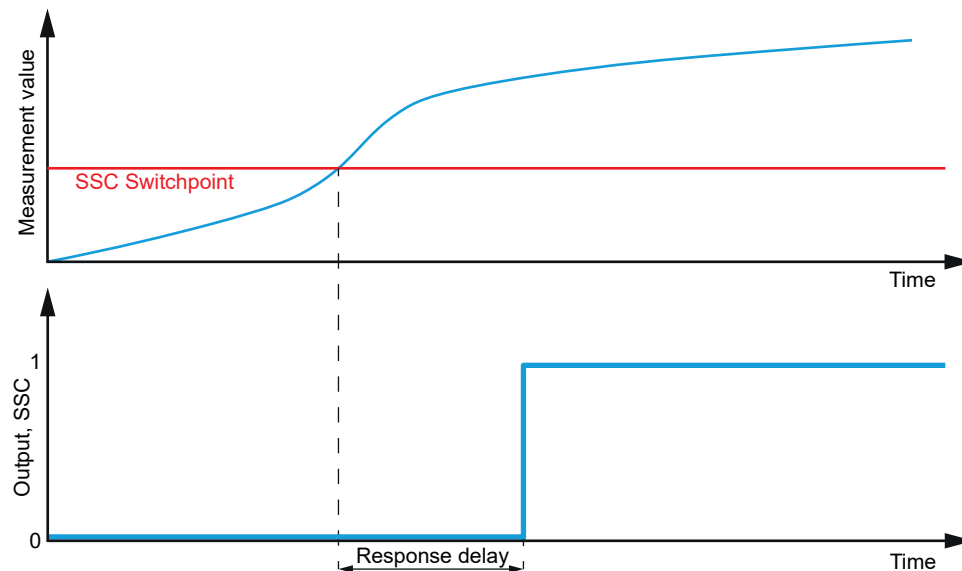

III. 2: Response Delay

Release Delay

Release Delay specifies the time the measured value must be lower (Point Mode) or outside (Window Mode) the switching points of the assigned SSC until its status would change to inactive (or active in inverted logic).

Fields of application:

- Elimination of incorrect switching operations at objects that cannot be 100% safely detected throughout the entire length.
- To suppress short-time signal loss in current transmission caused by known interference, e.g. mixers.
- To avoid bouncing contacts.
- For optimized execute time of downstream actuators triggered by the sensor output.

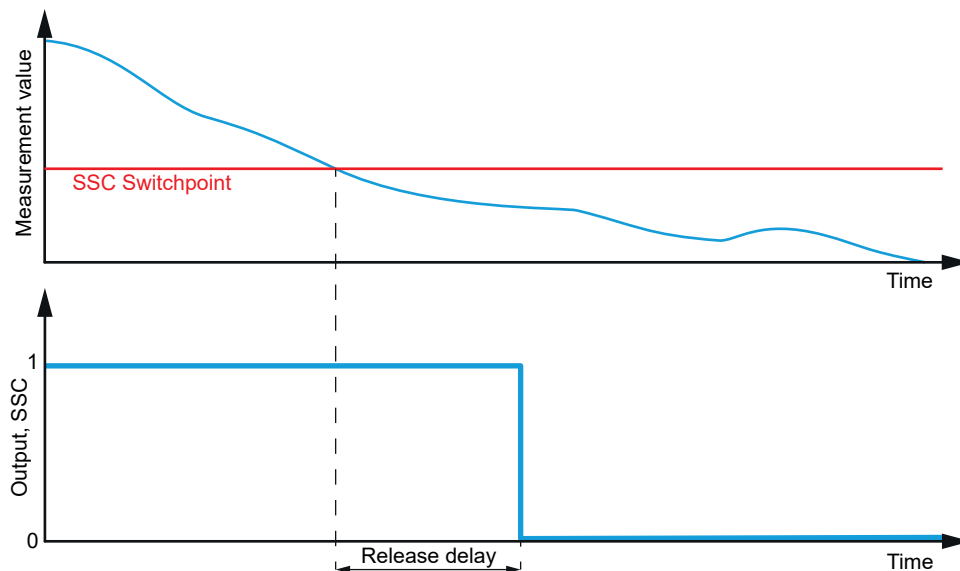

III. 3: Release Delay

Minimum Pulse Duration

Minimum Pulse Duration defines the minimum time the switching signal of the relevant SSC remains active or inactive after the status change.

Fields of application:

- Align sensor timing to a slower PLC.
- To avoid bouncing contacts.
- To avoid error pulses caused by short-time loss in correct signal transmission.
- For clock corrections.

Minimum Pulse Duration can be applied to:

- both slopes / active and inactive
- positive slope / active (or inactive, if the logic is inverted)
- negative slope / inactive (or active, if the logic is inverted)

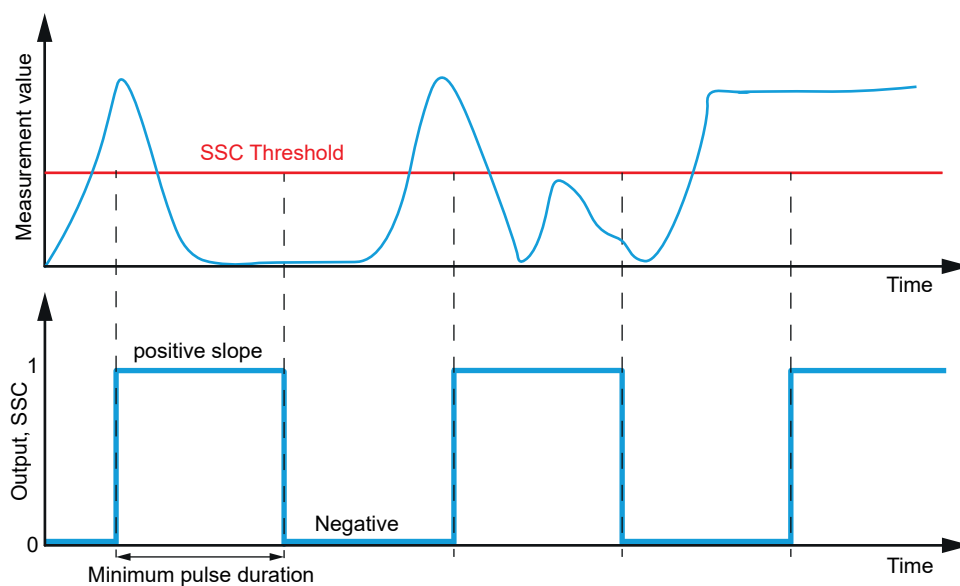

III. 4: Minimum Pulse Duration

For more detailed information on the following please refer to chapter [Annex \[48 \]](#).

IO-Link access: Timefilter

Name	Index	Subindex	Description
Release Delay	120	2	Sets the release delay time for SSC1. 0 to 60.000 ms
Response Delay	121	2	Sets the response delay time for SSC1. 0 to 60.000 ms
Minimum Pulse Duration	122	2	Sets the minimum pulse duration for SSC1. 0 to 60.000 ms
Minimum Pulse Duration Mode	122	3	Selects the slope mode. <ul style="list-style-type: none"> ▪ <i>Both Slopes: Positive and negative slopes are extended</i> ▪ <i>Positive Slope: Only positive slopes are extended</i> ▪ <i>Negative Slope: Only negative pulses are extended</i>

5.5 SSC2 configuration

This function is to set sensor switching point 2. Values within the range 450 to 2600 mm are permitted. Reaching the specified switching point 2 results in a sensor switching operation.

Parameters *Config*

Defines the switching logic for switching point 2, distinguishing between logic, mode and hysteresis.

- Logic: Defines whether the output is active or inactive when reaching the switching point
- Mode: Defines the output mode. Options are "Single Point" and "Deactivated"
- Hysteresis: Defines the output hysteresis.

IO-Link access: SSC2 Configuration

Name	Index	Subindex	Description
Setpoints			
SP1	62	1	Defines the setpoint 1 value for the switching signal channel.
SP2	62	2	Defines the setpoint 2 value for the switching signal channel.
Config			
Logic	63	1	Defines the logical representation of the switching signal SSC in the process data. <ul style="list-style-type: none"> ▪ 0: <i>High active</i> ▪ 1: <i>Low active</i>
Mode	63	2	Defines the evaluation mode for the switching signal SSC. <ul style="list-style-type: none"> ▪ 0: <i>Deactivated</i> ▪ 1: <i>Single point</i> ▪ 2: <i>Window</i> ▪ 3: <i>Two point</i>

5.5.1 Time filter

This function defines whether there is a delay in output 2 release (Release Delay) or in output 2 response (Response Delay). Furthermore, parameters *Minimal Pulse Duration* and *Minimal Pulse Duration Mode* define pulse duration and behavior.

For more detailed information on the following please refer to chapter [Annex \[▶ 48\]](#).

IO-Link access: Timefilter

Name	Index	Subindex	Description
Release Delay	120	12	Sets the release delay time for SSC2. 0 to 60.000 ms
Response Delay	121	12	Sets the response delay time for SSC2. 0 to 60.000 ms
Minimum Pulse Duration	122	12	Sets the minimum pulse duration for SSC2. 0 to 60.000 ms
Minimum Pulse Duration Mode	122	13	Selects the slope mode. <ul style="list-style-type: none"> ▪ <i>Both Slopes: Positive and negative slopes are extended</i> ▪ <i>Positive Slope: Only positive slopes are extended</i> ▪ <i>Negative Slope: Only negative pulses are extended</i>

5.6 SSC4 configuration

Each SSC is assigned an implemented switching counter that can be used either as a measured value or for diagnostics. The number of counts in each channel can be mapped to the measurement data channel (MDC) by setting the MDC source.

Counter trigger is the positive edge of the associated SSC. At sensor switchon, the counter assigned to SSC4 is automatically set to zero, even if SSC4 is disabled.

Parameters *Config*

SSC4 configuration allows for setup of a binary signal in relation with the number of SSC1 or SSC2 switching operations.

Integrated auto-reset and time filter enable setup of a full-featured batch counter e.g. for counting lot sizes without the need for any PLC software programming).

SSC4 offers the same functions as SSC1 and SSC2 (based on distance measurement), including time filter. Exception:

- No hysteresis settings since there will be only incremental counts.
- Setting of additional parameters SSC4 source and SSC4 auto reset.

For more detailed information on the following please refer to chapter [Annex \[▶ 48\]](#).

IO-Link access: SSC4 Configuration

Name	Index	Subindex	Description
Setpoints.SSC4 Param SP1	16386	1	Set the number of counts at which the SSC is set to active (or inactive if inverted)
Setpoints.SSC4 Param SP2	16386	2	Set the number of counts at at which the SSC is set to inactive (or active if inverted). This parameter is only active if SSC is set to window mode.
SSC4 Config.Logic	16387	1	Changes the Logic from NO to NC.
SSC4 Config.Mode	16387	2	Selection of the switching mode: <ul style="list-style-type: none"> ▪ Single Point ▪ Window
SSC4 Config.Selection	85	31	Selection of source for counter function: <ul style="list-style-type: none"> ▪ SSC1 Switch Counter ▪ SSC2 Switch Counter
SSC4 Config.Auto Reset	85	32	Autoreset of switch counter if given switch counts are reached. If autoreset is switched from disabled to enabled, the selected switch counter source is automatically being reset to zero.

5.6.1 Time filter

SSC4 Config.Auto Reset enabled allows for setup of a full-featured batch counter for lot sizes without the need for any manual reset. Time filters as response delay can help optimize the timing of a subsequent actor's execution.

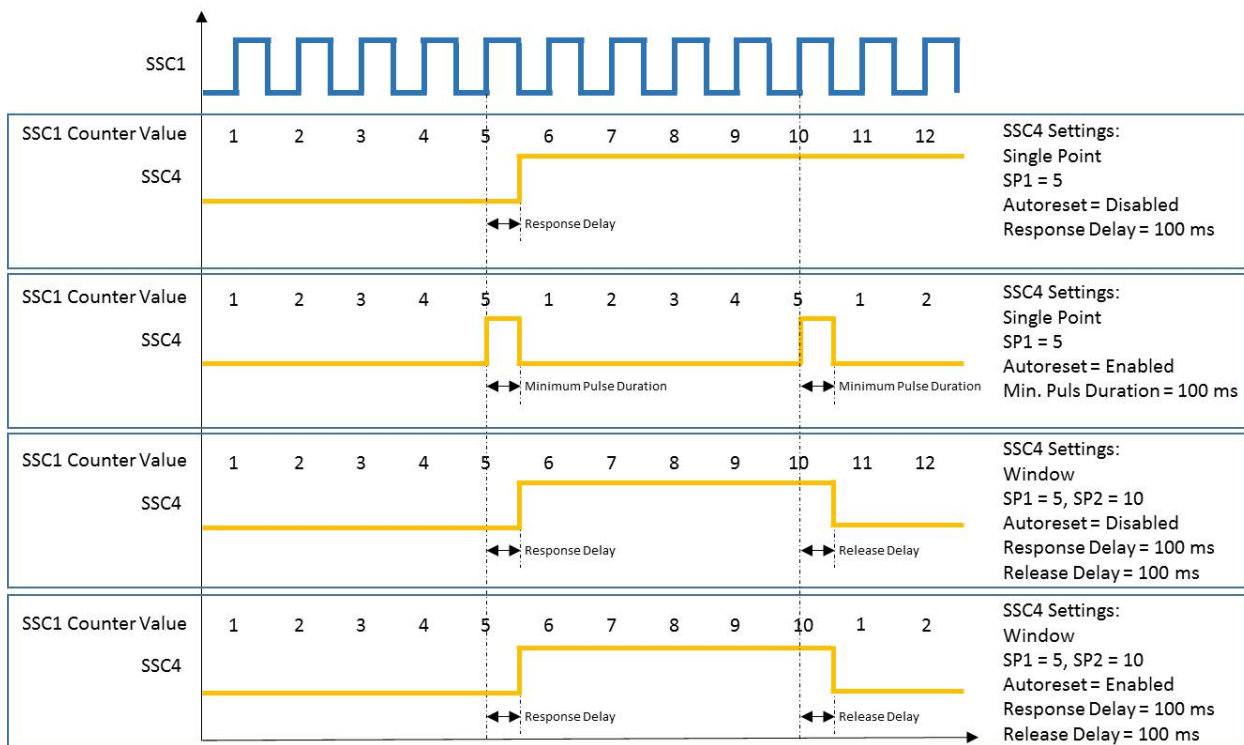

III. 5: SSC4/Counter behavior: Single Point or Window, Autoreset enabled or disabled

For more detailed information on the following please refer to chapter [Annex \[48\]](#).

IO-Link access: Timefilter

Name	Index	Subindex	Description
Response Delay.SSC4 Time	121	32	Sets the response delay time for SSC4. 0 to 60.000 ms
Release Delay.SSC4 Time	120	32	Sets the release delay time for SSC4. 0 to 60.000 ms
Minimum Pulse Duration.SSC4 Time	122	32	Sets the minimum pulse duration for SSC4. 0 to 60.000 ms
Minimum Pulse Duration.SSC4 Mode	122	33	Selects the slope mode. <ul style="list-style-type: none"> ■ Both Slopes ■ Positive Slope ■ Negative Slope

5.7 Hysteresis

Function *hysteresis* prevents unwanted switching operations by the switching output. The parameterized value of the hysteresis is the difference in distance between the points at which the switching output is activated and deactivated. Baumer recommends always setting the hysteresis not equal to 0.

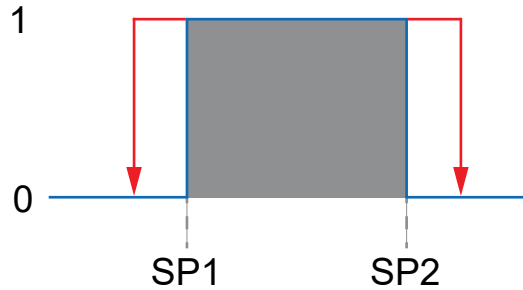

III. 6: Hysteresis in window mode

Function *hysteresis* provides the following parameters:

- *Hysteresis*: [-33 333 ... 33 000] A positive hysteresis value corresponds to a hysteresis aligned outside the window.

Example

- *Minimum switching point (SP1)*: 20 %
- *Maximum switching point (SP2)*: 60 %
- *Hysteresis*: 2 %

The switching output is active at a measured distance between 20 % and 60 %. If the distance drops from 20 % to 19 %, the switching output is still enabled because of hysteresis. However, as soon as the measured fill level falls below 18 % or rises above 62 %, the switching output will be disabled.

For further fill level change, the output will not be re-enabled until level is between 20 % and 60 % (parameterized switching point).

Switching output behavior

Hysteresis:

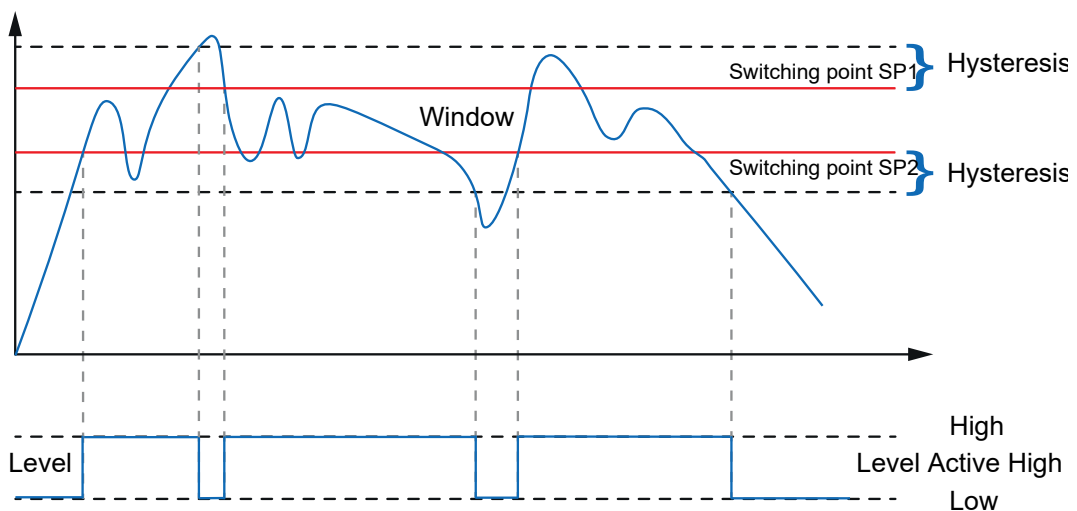

For more detailed information on the following please refer to chapter [Annex \[▶ 48\]](#).

IO-Link access: hysteresis

Name	Index	Subindex	Description
SSC1 Configuration			
Hyst	61	3	Define the hysteresis value of the switch window limits. A higher hysteresis can help to increase stability in critical applications.
SSC1 Alignment	69	5	Set hysteresis alignment. <ul style="list-style-type: none"> ▪ 1: <i>Left Aligned</i> ▪ 2: <i>Center Aligned</i> ▪ 3: <i>Right Aligned</i>
SSC2 Configuration			
Hyst	63	3	Define the hysteresis value of the switch window limits. A higher hysteresis can help to increase stability in critical applications.
SSC2 Alignment	69	15	Set hysteresis alignment. <ul style="list-style-type: none"> ▪ 1: <i>Left Aligned</i> ▪ 2: <i>Center Aligned</i> ▪ 3: <i>Right Aligned</i>

Also see about this

 [Annex \[▶ 48\]](#)

5.8 Teaching

Teach commands can be used for setting the switching points 1 and (SP1 and SP2). This is an easy way to compensate individual deviations such as mechanical backlash and mounting tolerances.

Different teaching methods are available. The available teaching methods depend on the applied sensor:

Teach procedure	OT300.GL	OT300.SL
Teach Point Offset	X	X
Teach Single Value	X	X
Teach Two Value	X	–
Teach Dynamic	X	X
Teach Analog	–	–



INFO

All LEDs light up for 1s when touching the teach field at the sensor with a ferromagnetic tool (tool has been recognized).

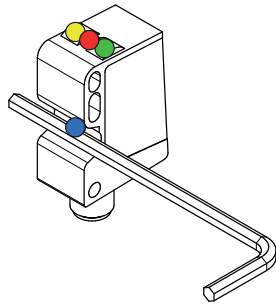
Teach access (Level 1): 1-point Teach

Touch the sensor's teach field with a ferromagnetic tool and hold for 2s. Once the sensor has recognized the tool all LEDs light up. After 2 seconds, the blue and green LEDs start flashing.

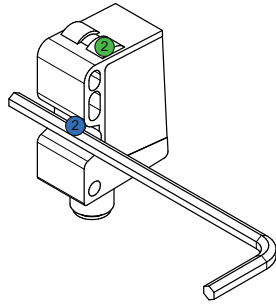

- Blue and green are LEDs flashing.

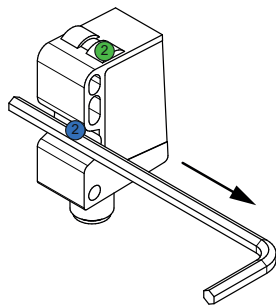

Withdraw tool from teach field.

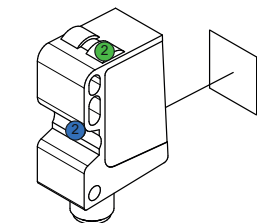

Place the object to be measured at the position to be defined as SP1.

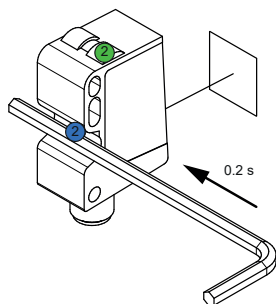

Briefly touch the teach field with the tool.

- The teaching operation was successful: the LEDs are off for an instant while the sensor continues in standard operation (LED green continuous, other LEDs illuminate according switching state).
- Teaching operation not successful: All LEDs are flashing quickly for 8 s (8 Hz).

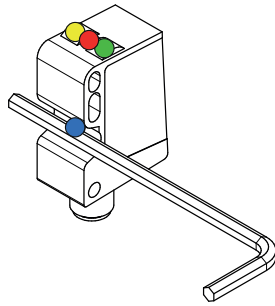
Teach access (level 2): Window Mode/analog measuring field

Touch the sensor's teach field with a ferromagnetic tool and hold for 4s. Once the sensor has recognized the tool all LEDs light up. After 2 seconds, the blue and green LEDs start flashing.

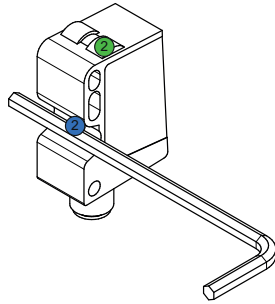

- Blue and green are LEDs flashing.

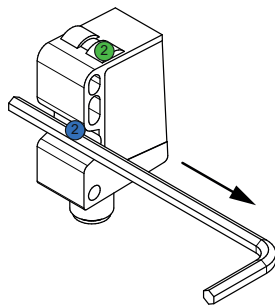

Withdraw tool from teach field.

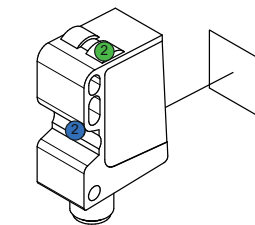

Place the object to be measured on the position to be defined as SP1/ start of measuring range.

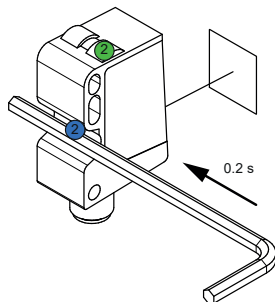

Briefly touch the teach field with the tool.

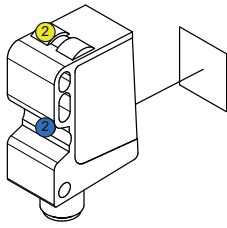

Place the object to be measured at the position to be defined as switching point SP2 / end of measuring range.

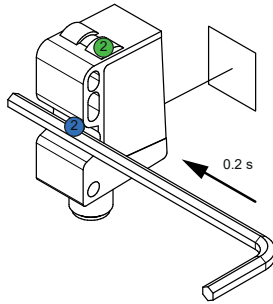

Briefly touch the teach field with the tool.

- Teaching operation successful: Sensor restores the factory settings. The LEDs are off for an instant and the sensor continues in standard operation (LED green continuous, other LEDs illuminate according to switching state).
- Teaching operation not successful: All LEDs are flashing quickly for 8 s (8 Hz).

5.8.1 Teach Point Offset

The function specifies the maximum deviation of the switching points in relation to the respective teach values. A value between +50% and -50% can be specified for SSC1 respectively SSC2.

Name	Index	Subindex	Description
Teachpoint Offset.SSC1	99	1	Specifies the offset value for switching output 1 in[%].
Teachpoint Offset.SSC2	99	11	Specifies the offset value for switching output 2 in[%].

5.8.2 Teach Single Value

The function is for teaching the recognized value (+/- Teach Point Offset) as switching point. Using teach commands, the switching points 1 and 2 (SP1 and SP2) are defined by placing the object at the desired position and executing the command. The switching output for a teach operation can be selected via *Baumer Sensor Suite (BSS)* and directly started via System Command (SC).

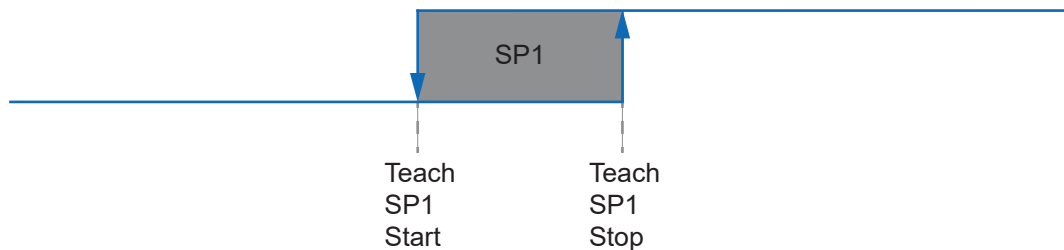

Name	Index	Subindex	Description
Teach Select	99	1	Selects the signal output for which the teach procedure is applied.
SC: Teach SP1	2	65	Starts the teach procedure for switching output 1.
SC: Teach SP2	2	66	Starts the teach procedure for switching output 2.
State	59	1	Indicates the status of the teach procedure.

5.8.3 Teach Two Value (OT300.GL only)

This function is for teaching a window the respective switching output is expected to perform a switching operation when an object has been detected in this area. In the event of major distance between TP1 and TP2, the switching point is set exactly in between. If the event of minor distance, the arithmetic center is taken into account.

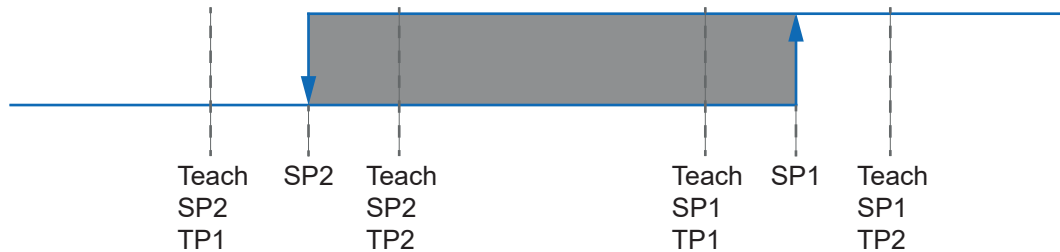

Name	Index	Subindex	Description
Teach Select	58	–	Selects the signal output for which the teach procedure is applied.
SC: Teach SP1 TP1	2	67	Starts the teach procedure for switching output 1 and sets the first teach point.
SC: Teach SP1 TP2	2	68	Starts the teach procedure for switching output 1 and sets the second teach point.
SC: Teach SP2 TP1	2	69	Starts the teach procedure for switching output 2 and sets the first teach point.
SC: Teach SP2 TP2	2	70	Starts the teach procedure for switching output 2 and sets the second teach point.
SC: Teach Apply	2	64	Calculates and applies the values learned.
SC: Teach Cancel	2	79	Cancel the teach procedure.
Flag SP1 TP1	59	2	Indicates the result of the teach procedure for SP1 TP1.
Flag SP1 TP2	59	3	Indicates the result of the teach procedure for SP1 TP2.
Flag SP2 TP1	59	4	Indicates the result of the teach procedure for SP2 TP1.
Flag SP2 TP2	59	5	Indicates the result of the teach procedure for SP2 TP2.
State	59	1	Indicates the status of the teach procedure.

5.8.4 Dynamic teaching

Dynamic teaching allows for defining the target values by evaluation of the minimum and maximum measured values within a time frame. This is helpful for moving and/or small objects.

The command sequence for dynamic teaching is the same in every switching mode:

- Place object at the desired switching distance
- Execute *Dynamic Teach SP Start (System Command)* to start data acquisition.
- Execute *Dynamic Teach SP Stop (System Command)* to end the data acquisition.
- Execute *Teach Apply (System Command)* to save the determined targets

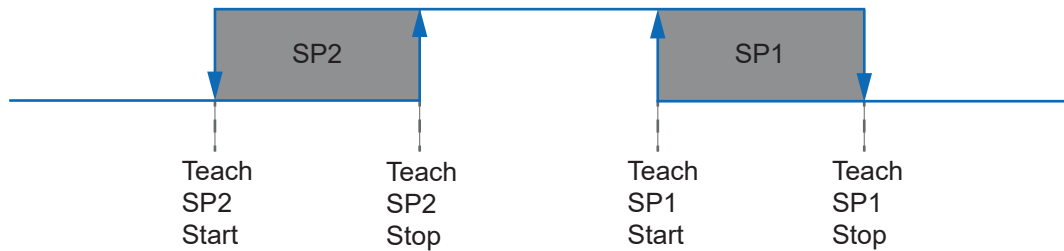

For more detailed information on the following please refer to chapter [Annex \[48\]](#).

IO-Link access: Dynamic teaching

Name	Index	Subindex	Description
Teach Select	58	–	Selects the signal output for which the teach procedure is applied.
SC: Dynamic Teach SP1 Start	2	67	Starts the dynamic teach procedure for switching output 1.
SC: Dynamic Teach SP1 Stop	2	68	Stops the dynamic teach procedure for switching output 1.
SC: Dynamic Teach SP2 Start	2	69	Starts the dynamic teach procedure for switching output 2.
SC: Dynamic Teach SP2 Stop	2	70	Stops the dynamic teach procedure for switching output 2.
SC: Teach Cancel	2	79	Cancel the teach procedure.

5.9 Signal Processing

You can choose between different default types of measurement.

Parameters	Description
Fast	Ideal for fast moving objects. The sensors are set to the shortest response time. Detection capability is identical to standard mode, but at reduced insensitivity against ambient light.
Standard	Standard setting with excellent performance and maximum immunity against highest ambient light.
Long Range	Twice the gain compared to standard mode, but at longer response time. Reduced hysteresis due to improved signal-to-noise ratio.

This will set the chip's response time according to the operating mode. The shorter the response time, the more limited will be the measuring range.

The following diagram is a rough overview on the signal processing chain. It starts with the measured value (top left) and ends either with a physical pin (top right) or output via process data bottom right.

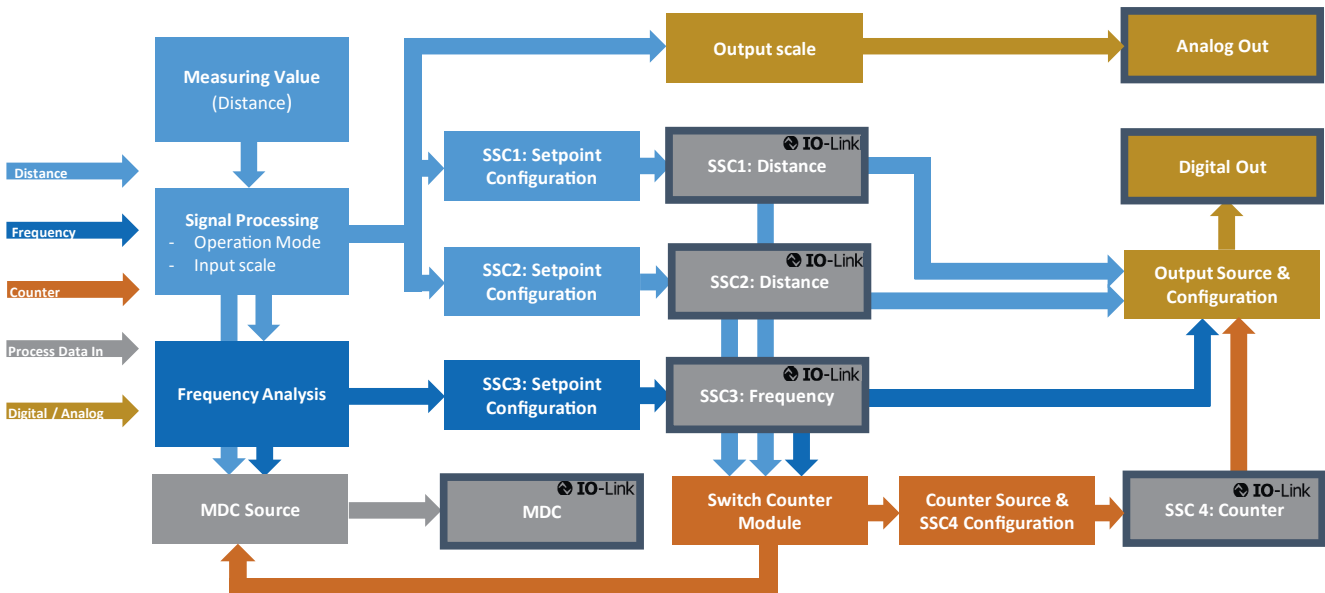

III. 7: Signal processing chain (diagram)

For more detailed information on the following please refer to chapter [Annex \[▶ 48\]](#).

IO-Link access: *Signal Processing*

Name	Index	Subindex	Description
Baumer Commands	1000	1	<ul style="list-style-type: none"> ▪ 48 = Standard Profile ▪ 49 = Fast Profile ▪ 50 = Long Range Profile
Active Profile	82	1	Currently active profile.
Expert			
Measurement Mode	77	1	Mode of measurement. <ul style="list-style-type: none"> ▪ 0 = Fast ▪ 1 = Standard ▪ 6 = Long Range
Maximum perturbation time	164	2	Duration (in units of time) until a signal (as defined in the parameter .Distance) becomes visible at the output.
Distance	164	3	Distance deviations from the current measured value which are ignored, if shorter than the period set by the parameter '.Maximum perturbation time'.
Smoothing Factor	165	2	Smoothing Factor

5.10

Temperature Settings

5.10.1

Temperature

This function is to select as temperature unit Kelvin, Celsius or Fahrenheit. This adjustable setting enables versatile sensor use in different environments and simplifies system integration in compliance to different regional or industrial standards. Users can select their preferred temperature scale to ensure precise measurements according to their specific requirements.

For more detailed information on the following please refer to chapter [Annex \[▶ 48\]](#).

IO-Link access: Temperature Settings

Name	Index	Subindex	Description
Temperature	74	1	Selects the temperature unit for the diagnostic function "Device Temperature". You have the following options: <ul style="list-style-type: none"> ▪ Kelvin ▪ Celsius ▪ Fahrenheit

5.11 Input/Output Settings

The switching function and switching type for the outputs can be set here.

Function *Switching function* defines its on/off behavior.

With **PNP sensors** the load is connected to both switching output and GND; with GND being the new reference point. In the event of signal change at the sensor, the transistor will switch through. Current flow is from +Vs to GND via transistor load which will close the circuit.

The output being inactive will have the control voltage virtually applied to +Vs blocking the transistor and this way eliminating current flow.

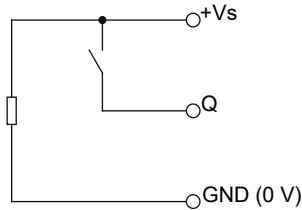

III. 8: Circuit diagram of PNP switching output

With **NPN sensors** the load is connected to switching output and +Vs; with +Vs being the reference point. Changing signals at the sensor will make the transistor switch through, current flow is from +Vs via transistor load to GND which will close the circuit.

The output being inactive will have the control voltage virtually applied to GND (0 V) blocking the transistor and this way eliminating current flow.

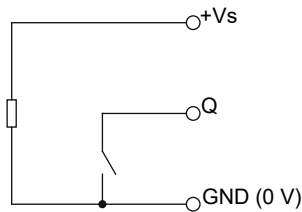

III. 9: Circuit diagram of NPN switching output

Push-pull switching outputs are basically a mixture of PNP and NPN switching outputs. The control is done in such a way that always only one transistor becomes conductive and thus the output is connected either with reference potential GND (0 V) or in active state with operating voltage potential +Vs. The connected control device may integrate any number of load RL resistors, the switching potentials adjust independently of size or wiring.

Interfaces for fast data transmission generally integrate push-pull switching outputs, as IO-Link in communication mode.

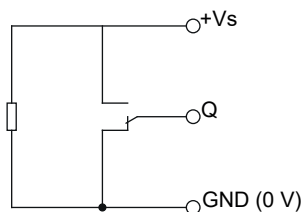

III. 10: Circuit diagram of push-pull switching output

Function *Switching function* provides the following parameters:

- *Off*
- *Push-Pull*
- *PNP*
- *NPN*

For more detailed information on the following please refer to chapter [Annex \[▶ 48\]](#).

IO-Link access: OUT1

Name	Index	Subindex	Description
OUT1 Circuit	164	3	Select the output circuit. Changes get active after a sensor reset. <ul style="list-style-type: none"> ▪ 1 = Push-Pull ▪ 2 = PNP ▪ 3 = NPN
OUT1 Function	165	2	Select the output function. <ul style="list-style-type: none"> ▪ 100 = SSC1 ▪ 400 = SSC4 ▪ 1701 = Alarm ▪ 1702 = Quality

IO-Link access: OUT2

Name	Index	Subindex	Description
OUT2 Circuit	164	3	Select the output circuit. Changes get active after a sensor reset. <ul style="list-style-type: none"> ▪ 1 = Push-Pull ▪ 2 = PNP ▪ 3 = NPN
OUT2 Function	165	2	Select the output function. <ul style="list-style-type: none"> ▪ 100 = SSC2 ▪ 400 = SSC4 ▪ 1701 = Alarm ▪ 1702 = Quality

Teaching access: switching logic



INFO

All LEDs light up for 1s when touching the teach field at the sensor with a ferromagnetic tool (tool has been recognized).

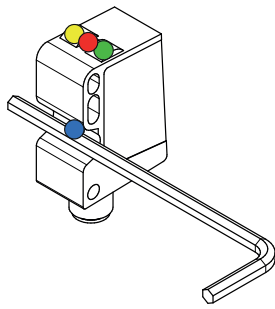

Touch the sensor's teach field with a ferromagnetic tool and hold for 6s. Once the sensor has recognized the tool all LEDs light up. After 2 seconds, the blue, yellow and green LEDs start flashing.

- The blue, green and yellow LEDs are flashing.

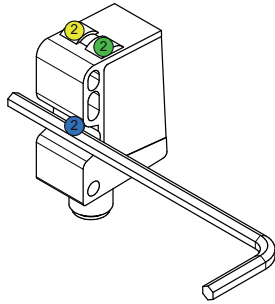

Withdraw the tool from the teach field.

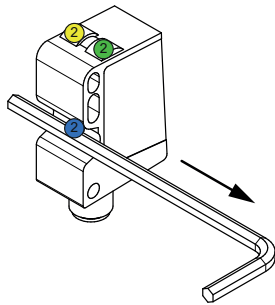

The LEDs indicate the set switching logic for the 1st switching output:

- LED green continuous: Switching logic NC (normally closed)
- LED amber continuous: Switching logic NO (normally open)

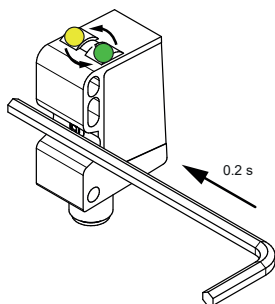

To change the switching logic, briefly touch the teach field with the tool.

Wait for 4 seconds to have the setting adopted.

- alternatively -

Touch the sensor's teach field with a ferromagnetic tool and hold for 2 s to change to the 2nd switching output.

The LEDs indicate the set switching logic for the 2st switching output:

- LED green and red continuous: Switching logic NC (normally closed)
- LED yellow and red continuous: Switching logic NO (normally open)

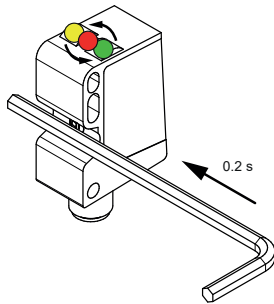

To change the switching logic, briefly touch the teach field with the tool.

Wait for 4 seconds to have the setting adopted.

- The teaching operation was successful: the LEDs are off for an instant while the sensor continues in standard operation (LED green continuous, other LEDs illuminate according switching state).
- Teaching operation not successful: All LEDs are flashing quickly for 8 s (8 Hz).

5.12 Local user interface

5.12.1 Local Teach Mode

This function is to set the local teaching mode (*qTeach*). You have choice between the modes *Xpert* (default settings) and *Xpress*.

The switching behavior depends on whether having defined *1-point teach* or *2-point teach (window teach)*(only available with OT300.GL).

Any failed teaching operation is visualized by LED flashing at 8 Hz for 2 seconds. The previous settings are restored. Teaching operation successful: Sensor returns to operating mode.

Mode	Level 1	Level2
Xpert Static	<p><i>1 point Teach</i></p> <p>Enable: briefly touch the teach field with a ferromagnetic tool (>2 ... <4 sec.)</p> <p>Green LED is flashing at 2 Hz</p> <p>Briefly touch the teach field for teaching the position</p>	<p><i>2 Point Teach</i> (only with OT300.GL).</p> <p>Enable: briefly touch the teach field with a ferromagnetic tool (>4 ... <6 sec.)</p> <p>Briefly touch the teach field for teaching switching point position SP1</p> <p>Briefly touch the teach field again for teaching SP2</p>
Xpert Dynamic	<p>Start</p> <p>Enable: briefly touch the teach field with a ferromagnetic tool (>2 ... <4 sec.)</p> <p>Green LED is flashing at 2 Hz</p> <p>Data acquisition starts once the tool has been withdrawn from the teach field</p> <p>Stop</p> <p>Briefly touch the teach field</p> <p>Accepted duration: 2 ... 15 sec.</p>	N/A
Xpress Static One Step Teach	<p>Enable: briefly touch the teach field with a ferromagnetic tool (>2 sec.)</p> <p>Green LED is flashing at 2 Hz</p>	N/A
Xpress Dynamic One Step Teach	<p>Start</p> <p>Touch the teach field with a ferromagnetic tool</p> <p>Stop</p> <p>Withdraw the tool from the teach field</p> <p>Accepted duration: 2 ... 15 sec.</p>	N/A

Mode	Level 3: Output Logic	Level 4: Factory Reset
Xpert Static	Enable: briefly touch the teach field with a ferromagnetic tool (>6 ... <8 sec.) Green & yellow LEDs are flashing at 2 Hz Touch the teach field to change the logic: <ul style="list-style-type: none"> ■ Green LED: standard ■ Yellow LED: Inverted 	Enable: briefly touch the teach field with a ferromagnetic tool (>8 ... <12 sec.) No further action required.
Xpert Dynamic	Enable: briefly touch the teach field with a ferromagnetic tool (>6 ... <8 sec.) Green & yellow LEDs are flashing at 2 Hz Touch the teach field to change the logic: <ul style="list-style-type: none"> ■ Green LED: standard ■ Yellow LED: Inverted 	Enable: briefly touch the teach field with a ferromagnetic tool (>8 ... <12 sec.) No further action required.
Xpress Static One Step Teach	N/A	N/A
Xpress Dynamic One Step Teach	N/A	N/A

For more detailed information on the following please refer to chapter [Annex \[▶ 48\]](#).

IO-Link access: *Local Teach Mode*

Name	Index	Subindex	Description
Local Teach Mode	100	1	Selects the teach mode if more than one is available. Teach modes: <ul style="list-style-type: none"> ■ 0 = XPert static ■ 1 = XPress static

5.12.2 *qTeach* lock

By default, *qTeach* is locked 5 min after switch-on to prevent unwanted manipulation. Lock can be disabled or locking time can be defined within the range 1 ... 120 min.

For more detailed information on the following please refer to chapter [Annex \[▶ 48\]](#).

IO-Link access: *qTeach* Lock

Name	Index	Subindex	Description
qTeach Time Out	80	1	<ul style="list-style-type: none"> ■ 0 = qTeach never locks ■ 0xFF = qTeach always off

5.12.3 LED Mode

The sensor LEDs can be disabled or inverted.

Standard behavior of LED indicators:

Function	Green	Yellow	Red
Power on	continuous	–	–
Short circuit	flashing	–	–
Output 1 active	–	continuous	–
Output 2 active	–	–	continuous

The following settings are enabled:

- *On*: LED standard behavior by default (see previous table).
- *Off*: LED is disabled, except for function *Find Me* being enabled.
- *Inverted*: LED behavior inverted to default as in the previous table.

For more detailed information on the following please refer to chapter [Annex \[▶ 48\]](#).

IO-Link access: LED display

Name	Index	Subindex	Description
LED Settings.Green Mode	79	2	Power on/short circuit Allowed values: On/Off
LED Settings.Yellow Mode	79	12	Connected to output 1 (LED on if output 1 is active) Allowed values: On/Off/Inverted
LED Settings.Red Mode	79	22	Connected to output 2 (LED on if output 2 is active) Allowed values: On/Off/Inverted
LED Settings.Blue Mode	79	32	Allowed values: On/Off

5.13 Quality Value

This function is for retrieving the sensor signal quality. The signal quality of an optical sensor refers to the intensity of the sensor-generated electrical or electronic signal in response to light.



INFO

In the event of poor signal quality check the installation position. Clean the sensor's reflector disc.

If the signal quality value falls below the set threshold, the quality bit is on *high*. Furthermore, the LED indicators visualize a measuring function being within the limits (flashing green-red).



INFO

LED indication is only present if there is no visualization of higher priority.

IO-Link access: Quality Value

Name	Index	Subindex	Description
Quality Parameters			
Value	64	1	Shows the signal quality [%].
Threshold	65	1	Selects the Quality Threshold A signal quality value below this threshold sets the quality bit to 1.

5.14 Device Access Locks

Access lock via IO-Link prevents unwanted or unauthorized change of the settings by the local sensor operating elements.

For more detailed information on the following please refer to chapter [Annex \[▶ 48\]](#).

IO-Link access: Device Access Locks

Name	Index	Subindex	Description
Local Parameterization	12	3	This lock prevents the device settings from being changed via local operating elements on the device. <ul style="list-style-type: none"> ▪ False (Unlocked) ▪ True (Locked)

5.15 Factory settings

This function restores default in the entire sensor values and parameterization. Default will be restored in the entire user settings.

You have the following options:

Designation	Description
Application Reset	Restores default in the parameterization of the technology-specific application. Identification parameters will be retained. If enabled, an upload to the data memory of the master is executed.
Restore Factory Settings	Restores default in all device parameters. Note: A download of the data memory can be executed at next device power on to overwrite the default settings.
Back-to-box	Restores default in all device parameters and communication is blocked until next power on of the device. Note: Disconnect device straight at the master port.

Overview on default settings

Adjustable parameters	Factory setting of the sensor	
MDC Configuration	Source	Distance
SSC1 Configuration	SP 1	2625 mm
	SP 2	2625 mm
	Logic	High active
	Mode	Single point
	Hysteresis	0
	SSC1 Alignment	Right Aligned
SSC2 Configuration	SP 1	2625 mm
	SP 2	2625 mm
	Logic	High active
	Mode	Single point
	Hysteresis	0
	SSC2 Alignment	Right Aligned
SSC4 Configuration	SP 1	10
	SP 2	50
	Logic	High active
	Mode	Disabled
	SSC4 Source Selection	Disabled
	SSC4 Auto Reset	Disabled
Signal Processing	Measurement Mode	Standard
	Maximum perturbation time	4 ms
	Distance	100 ms
	Smoothing Factor	5 ms

Adjustable parameters		Factory setting of the sensor
Temperature Settings	Temperature	Celsius
Local User Interface	Local Teach Mode	XPert static
	qTeach Time Out	5 min
	Green Mode	On
	Yellow Mode	On
	Blue Mode	On
Quality Parameters	Value	3000 ‰
	Threshold	150 ‰
Device Access Locks	Local Parameterization	False

For more detailed information on the following please refer to chapter [Annex \[▶ 48\]](#).

IO-Link access: factory settings

Name	Index	Subindex	Description
System Command	2	–	<ul style="list-style-type: none"> ▪ 129 = Application Reset ▪ 130 = Restore Factory Settings ▪ 131 = Back-to-box

Teach access (Level 4): Factory settings



INFO

qTeach will only reset the parameters set using *qTeach*.



INFO

All LEDs light up for 1s when touching the teach field at the sensor with a ferromagnetic tool (tool has been recognized).

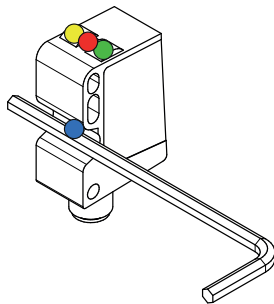

Touch the sensor's teach field with a ferromagnetic tool and hold for 8 seconds.

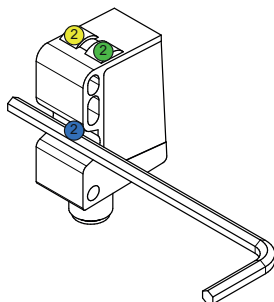

- Blue, green and yellow LEDs are flashing slowly (1 Hz).

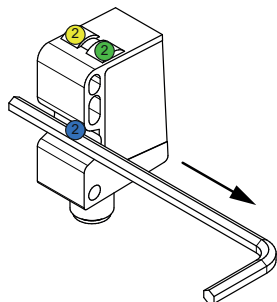

Withdraw the tool from the teach field.

- Teaching operation successful: Sensor restores the factory settings. The LEDs are off for an instant and the sensor continues in standard operation (LED green continuous, other LEDs illuminate according to switching state).
- Teaching operation not successful: All LEDs are flashing quickly for 8 s (8 Hz).

6 Diagnostic functions

6.1 Device temperature

This function reads the sensor's temperature information.

For more detailed information on the following please refer to chapter [Annex \[▶ 48\]](#).

IO-Link access: Device temperature

Name	Index	Subindex	Description
Baumer Command	1000	–	Device Temperature Reset
Device Temperature. Current	208	1	Current Device Temperature
Device Temperature. Min Resetable	208	2	Resetable Min Device Temperature
Device Temperature. Max Resetable	208	3	Resetable Max Device Temperature
Device Temperature. Min Lifetime	208	4	Minimum Device Temperature (over lifetime)
Device Temperature. Max Lifetime	208	5	Maximum Device Temperature (over lifetime)
Unit Selection. Temperature	74	1	Selection between temperature units: <ul style="list-style-type: none"> ▪ Kelvin ▪ Celsius ▪ Fahrenheit

6.2 Operating hours

The operating time of the sensor is permanently recorded. This function reads out the total of the sensor's operating hours.

For more detailed information on the following please refer to chapter [Annex \[▶ 48\]](#).

IO-Link access: Operating hours

Name	Index	Subindex	Description
Operation Time			
Lifetime	211	3	Operating time [h] (since production)
Lifetime	211	3	Operating time [h] (since production)
Lifetime	211	3	Operating time [h] (since production)
Lifetime	211	3	Operating time [h] (since production)

Also see about this

 [Annex \[▶ 48\]](#)

6.3 Device status

This function is for retrieving information on the device status.

For more detailed information on the following please refer to chapter [Annex \[▶ 48\]](#).

IO-Link access: Device status

Name	Index	Subindex	Description
Device Status	36	–	Indicator for the current device condition and diagnosis state. <ul style="list-style-type: none"> ■ 0 – Device is OK ■ 1 – Maintenance required ■ 2 – Out of specification ■ 3 – Functional check ■ 4 – Failure
Detailed Device Status	37	1	–

6.4 Histogram

Continuous recording of different diagnostic and process values for predictive maintenance or troubleshooting. The values are stored in histograms. For doing so, the potential value range divides into several intervals (bins); counting the number of events a new value is added to a bin.

Range	-40 ... +125°C
Number of Bins	16 Bin
Size of a Bin	165°C / 16 = 10.31 °C
Range of Bin 1	-40 ... -20.69 °C
Range of Bin 2	-20.69 ... -10.37 °C
...	...
Range of Bin 16	+114.69 ... +120 °C

Tab. 3: Example based on device temperature

By extracting the corresponding bins and information via IO-Link, histograms can map the distribution of the values displayed.

Histograms are available for:

- Device Temperature, Lifetime
- Power Supply Voltage, Lifetime
- Process Value 1: Distance, Resettable
- Process Value 2: Frequency, Resettable

For device temperature and supply voltage, a measured value is recorded every 10 seconds. Every measurement of process values is recorded.

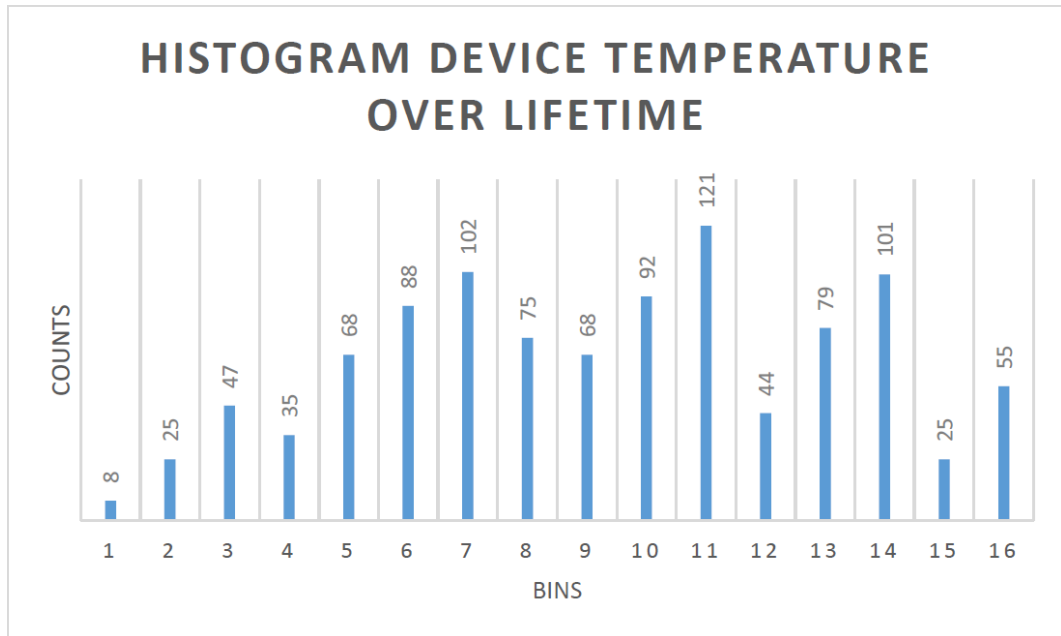

III. 11: Histogram of the device temperature (lifetime), example

The counts of each bin are stored as a 32-bit value.

For more detailed information on the following please refer to chapter [Annex \[48\]](#).

IO-Link access: Histogram voltage supply

Name	Index	Subindex	Description
Power Supply Voltage Life-time Histogram.Mode	262	1	Standard means: Linear partition of the range into bins.
Power Supply Voltage Life-time Histogram Unit	262	2	Indicates the unit
Power Supply Voltage Life-time Histogram RangeStart	262	3	Defines, where the range starts.
Power Supply Voltage Life-time Histogram RangeEnd	262	4	Defines, where the range ends.
Power Supply Voltage Life-time Histogram Nbr of Bins	262	5	Number of bins
Power Supply Voltage Life-time Histogram Bin1...16	262	11 ... 26	Number of counts of each bin

IO-Link access: Histogram device temperature

Name	Index	Subindex	Description
Temperature Lifetime Histogram.Mode	265	1	Standard means: Linear partition of the range into bins.
Temperature Lifetime Histogram Unit	265	2	Indicates the unit
Temperature Lifetime Histogram RangeStart	265	3	Defines, where the range starts.
Temperature Lifetime Histogram RangeEnd	265	4	Defines, where the range ends.

Name	Index	Subindex	Description
Temperature Lifetime Histogram Nbr of Bins	265	5	Number of bins
Temperature Lifetime Histogram Bin1...16	265	11 ... 26	Number of counts of each bin

IO-Link access: Histogram distance

Name	Index	Subindex	Description
Distance Resetable Histogram.Mode	257	1	Standard means: Linear partition of the range into bins.
Distance Resetable Histogram. Unit	257	2	Indicates the unit
Distance Resetable Histogram. RangeStart	257	3	Defines, where the range starts.
Distance Resetable Histogram. RangeEnd	257	4	Defines, where the range ends.
Distance Resetable Histogram.Nbr of Bins	257	5	Number of bins
Distance Resetable Histogram.Bin1...16	257	11 ... 26	Number of counts of each bin

IO-Link access: Histogram frequency

Name	Index	Subindex	Description
Frequency Resetable Histogram.Mode	260	1	Standard means: Linear partition of the range into bins.
Frequency Resetable Histogram. Unit	260	2	Indicates the unit
Frequency Resetable Histogram. RangeStart	260	3	Defines, where the range starts.
Frequency Resetable Histogram. RangeEnd	260	4	Defines, where the range ends.
Frequency Resetable Histogram.Nbr of Bins	260	5	Number of bins
Frequency Resetable Histogram.Bin1...16	260	11 ... 26	Number of counts of each bin

6.5 Identification

These functions read or write sensor identification information.

For more detailed information on the following please refer to chapter [Annex ▸ 48](#).

IO-Link access: Identification

Name	Index	Subindex	Description
Vendor Name	16	–	The vendor name that is assigned to a Vendor ID. Default value: Baumer Electric AG
Vendor Text	17	–	Additional information about the vendor. Default value: www.baumer.com
Product Name	18	–	Complete product name.
Product ID	19	–	Vendor-specific product or type identification (e.g. item number or model number).
Product Text	20	–	Additional product information for the device.
Application-specific Tag	24	–	Possibility to mark a device with user- or application-specific information.
Function Tag	25	–	User specified function tag.
Location Tag	26	–	User specified location tag.
Serial Number	21	–	Unique, vendor-specific identifier of the individual device.
Firmware Revision	23	–	Unique, vendor-specific identifier of the firmware revision of the individual device.
Hardware Revision	22	–	Unique, vendor-specific identifier of the hardware revision of the individual device.

7 Annex

7.1 IO-Link

7.1.1 PDI

subindex	bit offset	data type	allowed values	default value	acc. restr.	mod. other var.	excl. from DS	name	description
1	16	16-bit Integer	-32760 = Out of Range (-), 32760 = Out of Range (+), 32764 = No Data, 450..2600					Measurement Value	
3	0	Boolean						SSC1/Distance	
4	1	Boolean						SSC2/Distance	
5	2	Boolean						Quality Bit	
6	3	Boolean						Alarm Output	
7	5	Boolean						SSC4/Counter	

Octet 0

bit offset	31	30	29	28	27	26	25	24
subindex	1							
element bit	15	14	13	12	11	10	9	8

Octet 1

bit offset	23	22	21	20	19	18	17	16
subindex	1							
element bit	7	6	5	4	3	2	1	0

Octet 2

bit offset	15	14	13	12	11	10	9	8
subindex	//////	//////	//////	//////	//////	//////	//////	//////

Octet 3

bit offset	7	6	5	4	3	2	1	0
subindex	//////	//////	7	//////	6	5	4	3

7.1.2 PDO

subindex	bit offset	data type	allowed values	default value	acc. restr.	mod. other var.	excl. from DS	name	description
1	0	Boolean						Disable Laser	
2	1	Boolean						Find Me	

Octet 0

bit offset	7	6	5	4	3	2	1	0
subindex							2	1

7.1.3 Identification

Index	Subindex	Name	Data type	Access rights	Value range	Description
16	0	Vendor Name	String	R	ASCII	Vendor name that is assigned to a vendor ID, e. g. Baumer.
17	0	Vendor Text	String	R	ASCII	Additional information about the vendor, e. g. www.baumer.com
18	0	Product Name	String	R	ASCII	Complete product name, e. g. IFxx.DxxL.
19	0	Product ID	String	R	ASCII	Vendor-specific product or type identification, e. g. item number or model number.
20	0	Product Text	String	R	ASCII	Additional product information for the device.
21	0	Serial number	String	R	ASCII	Unique, vendor-specific identifier of the individual device.
22	0	Hardware revision	String	R	ASCII	Unique, vendor-specific identifier of the hardware revision of the individual device, e. g. 00.00.01
23	0	Firmware Revision	String	R	ASCII	Unique, vendor-specific identifier of the firmware revision of the individual device, e.g. 00.00.04
24	0	Application specific Tag	String	R/W	ASCII	Possibility to mark a device with user-or application-specific information.
25	0	Function Tag	String	R/W	ASCII	Possibility to mark a device with function-specific information.
26	0	Location Tag	String	R/W	ASCII	Possibility to mark a device with location-specific information.

7.1.4 Parameter

7.1.4.1 System Command

Index	Subindex	Name	Data type	Access rights	Value range	Description
2	–	System Command	UInt8	W		<ul style="list-style-type: none"> ■ 128 = Device Reset ■ 129 = Application Reset ■ 130 = Restore Factory Settings ■ 131 = Back-to-box
1000	–	Baumer Commands	UInt8	W		<ul style="list-style-type: none"> ■ 255 = Alignment Assistance

7.1.4.2 Measurement Values

Index	Subindex	Name	Data type	Access rights	Value range	Description
88	1	Distance	UInt16	R		Returns the measured distance.
88	11	Counter Value	UInt16	R		Returns the current counter value.

7.1.4.2.1 SwitchCounts

Index	Subindex	Name	Data type	Access rights	Value range	Description
1000	–	Baumer Commands - SSC1 Switch Counts Reset	UInt8	W		12 = SSC1 Switch Counts Reset
1000	–	Baumer Commands - SSC2 Switch Counts Reset	UInt8	W		13 = SSC2 Switch Counts Reset
1000	–	Baumer Commands - SSC4 Switch Counts Reset	UInt8	W		15 = SSC4 Switch Counts Reset
225	2	Switch Counts SSC1 Resettable	UInt32	R		SSC1 Resettable Switch Counts
225	12	Switch Counts SSC2 Resettable	UInt32	R		SSC2 Resettable Switch Counts

Index	Subindex	Name	Data type	Access rights	Value range	Description
225	32	Switch Counts SSC4 Resetable	Uint32	R		SSC4 Resetable Switch Counts

7.1.4.3 MDC Configuration

Index	Subindex	Name	Data type	Access rights	Value range	Description
83	1	Source	Uint8	R/W		MDC selection source. <ul style="list-style-type: none"> ▪ Distance ▪ Quality ▪ SSC1 Switch Counter ▪ SSC2 Switch Counter ▪ SSC4 Switch Counter
MDC Descriptor						
16512	1	Lower Value	Uint16	R/W		Shows the lower value of measurement range.
16512	2	Upper Value	Uint32	R/W		Shows the upper value of measurement range.
16512	3	Unit Code	Uint8	R		Shows the unique code for the physical unit.
16512	4	Scale	Uint16	R/W		Shows the multiplier for the measurement value - 10exp(scale).

7.1.4.4 SSCx Configuration

SSC1 Configuration

Index	Subindex	Name	Data type	Access rights	Value range	Description
Setpoints						
60	1	SP1	Uint32	R/W	100 ... 2700	Defines the setpoint 1 value for the switching signal channel.
60	2	SP2	Uint32	R/W	100 ... 2700	Defines the setpoint 2 value for the switching signal channel.
Config						
61	1	Logic	Uint8	R/W		Defines the logical representation of the switching signal SSC in the process data. <ul style="list-style-type: none"> 0: High active 1: Low active
61	2	Mode	Uint8	R/W		Defines the evaluation mode for the switching signal SSC. <ul style="list-style-type: none"> 0: Deactivated 1: Single point 2: Window 3: Two point
61	3	Hyst	Uint32	R/W		Defines the hysteresis at the switchpoint. A higher hysteresis may help to increase stability in critical applications.
69	5	SSC1 Alignment	Uint32	R	1E-05 .. 0.022	Set hysteresis alignment. <ul style="list-style-type: none"> 1: Left Aligned 2: Center Aligned 3: Right Aligned
Timefilter						
120	2	Releasy Delay SSC1 Time	Uint32	R/W	60000 ... 0	Sets / indicates the release delay time in milliseconds for SSC1.
121	2	Response Delay SSC1 Time	Uint32	R/W	60000 ... 0	Sets / indicates the response delay time in milliseconds for SSC1.
122	2	Minimal Pulse Duration SSC1 Time	Uint32	R/W	60000 ... 0	Sets / indicates the minimal pulse length in milliseconds for the respective switching signal channel (SSC).

Index	Subindex	Name	Data type	Access rights	Value range	Description
122	3	Minimal Pulse Duration SSC1 Mode	Uint8	R/W		<ul style="list-style-type: none"> ▪ 1: Both Pulses: positive and negative pulses are prolonged ▪ 2: Positive Pulse: only positive pulses are prolonged ▪ 3: Negative Pulse: only negative pulses are prolonged

SSC2 Configuration

Index	Subindex	Name	Data type	Access rights	Value range	Description
Setpoints						
62	1	SP1	Uint32	R/W	100 ... 2700	Defines the setpoint 1 value for the switching signal channel.
62	2	SP2	Uint32	R/W	100 ... 2700	Defines the setpoint 2 value for the switching signal channel.
Config						
63	1	Logic	Uint8	R/W		Defines the logical representation of the switching signal SSC in the process data. <ul style="list-style-type: none"> ▪ 0: High active ▪ 1: Low active
63	2	Mode	Uint8	R/W		Defines the evaluation mode for the switching signal SSC. <ul style="list-style-type: none"> ▪ 0: Deactivated ▪ 1: Single point ▪ 2: Window ▪ 3: Two point
63	3	Hyst	Uint32	R/W		Defines the hysteresis at the switchpoint. A higher hysteresis may help to increase stability in critical applications.
69	15	SSC2 Alignment	Uint32	R	1E-05 .. 0.022	Set hysteresis alignment. <ul style="list-style-type: none"> ▪ 1: Left Aligned ▪ 2: Center Aligned ▪ 3: Right Aligned

Index	Subindex	Name	Data type	Access rights	Value range	Description
Timefilter						
120	12	Release Delay SSC2 Time	Uint32	R/W	60000 ... 0	Sets / indicates the release delay time in milliseconds for SSC1.
121	12	Response Delay SSC2 Time	Uint32	R/W	60000 ... 0	Sets / indicates the response delay time in milliseconds for SSC1.
122	12	Minimal Pulse Duration SSC2 Time	Uint32	R/W	60000 ... 0	Sets / indicates the minimal pulse length in milliseconds for the respective switching signal channel (SSC).
122	13	Minimal Pulse Duration SSC2 Mode	Uint8	R/W		<ul style="list-style-type: none"> ▪ 1: Both Pulses: positive and negative pulses are prolonged ▪ 2: Positive Pulse: only positive pulses are prolonged ▪ 3: Negative Pulse: only negative pulses are prolonged

SSC4 Configuration

Index	Subindex	Name	Data type	Access rights	Value range	Description
Setpoints						
16386	1	SP1	Uint32	R/W	60000 ... 0	Defines the setpoint 1 value for the switching signal channel.
16386	2	SP2	Uint32	R/W	60000 ... 0	Defines the setpoint 2 value for the switching signal channel.
Config						
16387	1	Logic	Uint8	R/W		Defines the logical representation of the switching signal SSC in the process data. <ul style="list-style-type: none"> ▪ 0: High active ▪ 1: Low active
16387	2	Mode	Uint8	R/W		Defines the evaluation mode for the switching signal SSC. <ul style="list-style-type: none"> ▪ 0: Deactivated ▪ 1: Single point ▪ 2: Window
85	31	SSC4 Source Selection	Uint8	R/W		Select the process value that is shown on the MDC channel. <ul style="list-style-type: none"> ▪ 0: Disabled ▪ 1: SSC1 Switch Counter ▪ 2: SSC2 Switch Counter

Index	Subindex	Name	Data type	Access rights	Value range	Description
85	32	SSC4 Auto Reset	UInt8	R/W		SSC4 Auto reset <ul style="list-style-type: none"> ▪ 0: Disabled ▪ 1: Enabled
Timefilter						
120	12	Release Delay SSC2 Time	UInt32	R/W	60000 ... 0	Sets / indicates the release delay time in milliseconds for SSC1.
121	12	Response Delay SSC2 Time	UInt32	R/W	60000 ... 0	Sets / indicates the response delay time in milliseconds for SSC1.
122	12	Minimal Pulse Duration SSC2 Time	UInt32	R/W	60000 ... 0	Sets / indicates the minimal pulse length in milliseconds for the respective switching signal channel (SSC).
122	13	Minimal Pulse Duration SSC2 Mode	UInt8	R/W		<ul style="list-style-type: none"> ▪ 1: Both Pulses: positive and negative pulses are prolonged ▪ 2: Positive Pulse: only positive pulses are prolonged ▪ 3: Negative Pulse: only negative pulses are prolonged

7.1.4.5 Teach

Index	Subindex	Name	Data type	Access rights	Value range	Description
Teach Point Offset						
99	1	Teachpoint Offset.SSC1	UInt32	R/W	-50...50	Teachpoint offset for SSC1.
99	11	Teachpoint Offset.SSC2	UInt32	R/W	-50...50	Teachpoint offset for SSC2.
Teach Single Value						
58	1	Teach Select	UInt8	R/W		Selects the switching signal channel for which a teach procedure will be applied. <ul style="list-style-type: none"> ▪ 1 = SSC.1 ▪ 2 = SSC.2
2	–	System Command - Teach SP1	UInt8	W		Determine setpoint 1 in an single teach procedure. <ul style="list-style-type: none"> ▪ 65 = Teach SP1

Index	Subindex	Name	Data type	Access rights	Value range	Description
2	–	System Command - Teach SP2	UInt8	W		Determine setpoint 2 in an single teach procedure. <ul style="list-style-type: none"> 66 = Teach SP2
59	1	State	UInt4	R		Indicates the current state of the teach procedure. <ul style="list-style-type: none"> 0 = Idle 1 = SP1 success 2 = SP2 success 3 = SP1, SP2 success 4 = Wait for command 5 = Busy 7 = Error
Teach Two Value						
58	1	Teach Select	UInt8	R/W		Selects the switching signal channel for which a teach procedure will be applied. <ul style="list-style-type: none"> 1 = SSC.1 2 = SSC.2
2	–	System Command - Teach SP1 TP1	UInt8	W		Determine teachpoint 1 for setpoint 1. <ul style="list-style-type: none"> 67 = Teach SP1
2	–	System Command - Teach SP1 TP2	UInt8	W		Determine teachpoint 2 for setpoint 1. <ul style="list-style-type: none"> 68 = Teach SP2
2	–	System Command - Teach SP2 TP1	UInt8	W		Determine teachpoint 2 for setpoint 1. <ul style="list-style-type: none"> 69 = Teach SP1
2	–	System Command - Teach SP2 TP2	UInt8	W		Determine teachpoint 2 for setpoint 2. <ul style="list-style-type: none"> 70 = Teach SP2
2	–	System Command - Teach Apply	UInt8	W		Calculate and apply setpoint. <ul style="list-style-type: none"> 64 = Teach Apply
2	–	System Command - Teach Cancel	UInt8	W		Cancel ongoing teach procedure. <ul style="list-style-type: none"> 79 = Teach Cancel

Index	Subindex	Name	Data type	Access rights	Value range	Description
80	–	Single Value Teach Mode	UInt16	R/W		<ul style="list-style-type: none"> 0 = Light State Teach (-AUTOSET Percent) 1 = Dark State Teach (+AUTOSET Percent) 2 = Midpoint Teach (+0)
59	2	Flag SP1 TP1	Boolean	R		<ul style="list-style-type: none"> false = Initial or not ok true = OK
59	3	Flag SP1 TP2	Boolean	R		
59	4	Flag SP2 TP1	Boolean	R		
59	5	Flag SP2 TP2	Boolean	R		
59	1	State	UInt4	R		<p>Indicates the current state of the teach procedure.</p> <ul style="list-style-type: none"> 0 = Idle 1 = SP1 success 2 = SP2 success 3 = SP1, SP2 success 4 = Wait for command 5 = Busy 7 = Error
Teach-in Dynamic						
58	1	Teach Select	UInt8	R/W		<p>Selects the switching signal channel for which a teach procedure will be applied.</p> <ul style="list-style-type: none"> 1 = SSC.1 2 = SSC.2
2	–	System Command - Teach SP1 Start	UInt8	W		<p>Start dynamic teach for setpoint 1.</p> <ul style="list-style-type: none"> 71 = Teach SP1 Start
2	–	System Command - Teach SP1 Stop	UInt8	W		<p>Stop dynamic teach for setpoint 1.</p> <ul style="list-style-type: none"> 72 = Teach SP1 Stop
2	–	System Command - Teach SP2 Start	UInt8	W		<p>Start dynamic teach for setpoint 2.</p> <ul style="list-style-type: none"> 73 = Teach SP1 Start
2	–	System Command - Teach SP2 Stop	UInt8	W		<p>Stop dynamic teach for setpoint 2.</p> <ul style="list-style-type: none"> 74 = Teach SP1 Stop

Index	Subindex	Name	Data type	Access rights	Value range	Description
2	–	System Command - Teach Cancel	UInt8	W		<ul style="list-style-type: none"> 79 = Teach Cancel
59	1	State	UInt4	R		<p>Indicates the current state of the teach procedure.</p> <ul style="list-style-type: none"> 0 = Idle 1 = SP1 success 2 = SP2 success 3 = SP1, SP2 success 4 = Wait for command 5 = Busy 7 = Error

7.1.4.6 Signal Processing

Index	Subindex	Name	Data type	Access rights	Value range	Description
1000	1	Baumer Commands	UInt8	W		<ul style="list-style-type: none"> 48 = Standard Profile 49 = Fast Profile 50 = Long Range Profile
82	1	Active Profile	UInt8	W		Currently active profile.
Expert						
77	1	Measurement Mode	UInt8	R/W		<p>Mode of measurement.</p> <ul style="list-style-type: none"> 0 = Fast 1 = Standard 6 = Long Range
164	2	Maximum perturbation time	UInt32	R/W	0...65535	Duration (in units of time) until a signal (as defined in the parameter .Distance) becomes visible at the output.
164	3	Distance	UInt32	R/W	0...65535	Distance deviations from the current measured value which are ignored, if shorter than the period set by the parameter '.Maximum perturbation time'.
165	2	Smoothing Factor	UInt32	R/W	0...65535	Smoothing Factor

7.1.4.7 Temperature Settings

Index	Subindex	Name	Data type	Access rights	Value range	Description
74	1	Temperature	Uint16	R/W		Select temperature unit. <ul style="list-style-type: none"> ■ 1000 = Kelvin ■ 1001 = Celsius ■ 1002 = Fahrenheit

7.1.4.8 Input/Output Settings

Index	Subindex	Name	Data type	Access rights	Value range	Description
78	1	OUT1 Circuit	Uint8	R/W		Select the output circuit. Changes get active after a sensor reset. <ul style="list-style-type: none"> ■ 1 = Push-Pull ■ 2 = PNP ■ 3 = NPN
78	2	OUT1 Function	Uint16	R/W		Select the output function. <ul style="list-style-type: none"> ■ 100 = SSC1 ■ 400 = SSC4 ■ 1701 = Alarm ■ 1702 = Quality
78	3	OUT2 Circuit	Uint8	R/W		Select the output circuit. Changes get active after a sensor reset. <ul style="list-style-type: none"> ■ 1 = Push-Pull ■ 2 = PNP ■ 3 = NPN
78	4	OUT2 Function	Uint16	R		Select the output function. <ul style="list-style-type: none"> ■ 200 = SSC2 ■ 400 = SSC4 ■ 1701 = Alarm ■ 1702 = Quality

7.1.4.9 Local User Interface

Index	Subindex	Name	Data type	Access rights	Value range	Description
100	1	Local Teach Mode	Uint8	R/W		Selects the teach mode if more than one is available. Teach modes: <ul style="list-style-type: none"> ■ 0 = XPert static ■ 1 = XPress static
80	1	qTeach Time Out	Uint8	R/W		Time until qTeach is locked. If 0 qTeach never locks. If 0xFF qTeach is always off.
LED Settings						
79	2	Green Mode	Uint8	R/W		Switches the LED off, no change of other function. <ul style="list-style-type: none"> ■ 0 = Off ■ 1 = On
79	12	Yellow Mode	Uint8	R		Switches the LED off, no change of other function, or inverts the relationship between LED and pin, Inverted: Pin high, LED off, On: Pin high, LED on. <ul style="list-style-type: none"> ■ 0 = Off ■ 1 = On ■ 2 = Inverted
79	22	Blue Mode	Uint8	R/W		Switches the LED off, no change of other function. <ul style="list-style-type: none"> ■ 0 = Off ■ 1 = On
79	32	Red Mode	Uint8	R/W		Switches the LED off, no change of other function, or inverts the relationship between LED and pin, Inverted: Pin high, LED off, On: Pin high, LED on. <ul style="list-style-type: none"> ■ 0 = Off ■ 1 = On ■ 2 = Inverted

7.1.4.10 Quality Parameters

Index	Subindex	Name	Data type	Access rights	Value range	Description
64	1	Value	Uint16	R	0...99 = No measurement possible, 100...3000	Indicates the quality of the reflected signal in [%].
65	1	Threshold	Uint16	R/W	0...99 = No measurement possible, 100...3000	Sets the threshold for the quality bit which is mapped to the input process data and used for the LED weak signal indication.

7.1.4.11 Device Access Locks

Index	Subindex	Name	Data type	Access rights	Value range	Description
12	1	Parameter Write Access	Boolean	R/W		This lock prevents the write access to all read/write parameters of the device except for the parameter 'Device Access Locks'. <ul style="list-style-type: none"> ▪ Unlocked (False) ▪ Locked (True)
12	2	Data Storage	Boolean	R/W		This lock prevents the write access to the device parameters via the data storage mechanism. <ul style="list-style-type: none"> ▪ Unlocked (False) ▪ Locked (True)
12	3	Local Parameterization	Boolean	R/W		This lock prevents the device settings from being changed via local operating elements on the device. <ul style="list-style-type: none"> ▪ Unlocked (False) ▪ Locked (True)
12	4	Local User Interface	Boolean	R/W		This lock prevents the access to the device settings and display via a local user interface. The user interface is disabled. <ul style="list-style-type: none"> ▪ Unlocked (False) ▪ Locked (True)

7.1.5 Diagnosis

7.1.5.1 Device Status

Index	Subindex	Name	Data type	Access rights	Value range	Description
64	1	Device Status	UInt32	R		Indicator for the current device condition and diagnosis state. <ul style="list-style-type: none"> ■ 0 = Device is OK ■ 1 = Maintenance required ■ 2 = Out of specification ■ 4 = Failure
64	2	Detailed Device Status	Array	R		List of all currently pending events in the device.

7.1.5.2 Device Temperature

Index	Subindex	Name	Data type	Access rights	Value range	Description
1000	–	Baumer Command	Int32	W		Device Temperature Reset
208	1	Device Temperature. Current	Int32	R		Current Device Temperature
208	2	Device Temperature. Min Resetable	Int32	R		Resetable Min Device Temperature
208	3	Device Temperature. Max Resetable	Int32	R		Resetable Max Device Temperature
208	4	Device Temperature. Min Lifetime	Int32	R		Minimum Device Temperature (over lifetime)
208	5	Device Temperature. Max Lifetime	Int32	R		Maximum Device Temperature (over lifetime)
74	1	Unit Selection. Tem- perature	Int16	R/W		Selection between temperature units: <ul style="list-style-type: none"> ■ Kelvin ■ Celsius ■ Fahrenheit

7.1.5.3 Power Supply

Index	Subindex	Name	Data type	Access rights	Value range	Description
1000	–	Baumer Command	Int32	W		Power Supply Voltage Reset
210	1	Power Supply. Current	Int32	R		Current Power Supply Voltage
210	2	Power Supply. Min Re- setable	Int32	R		Resetable Min Power Supply Voltage
210	3	Power Supply. Max Resetable	Int32	R		Resetable Max Power Supply Voltage
210	4	Power Supply. Min Lifetime	Int32	R		Minimum Power Supply Voltage (over lifetime)
210	5	Power Supply. Max Lifetime	Int32	R		Maximum Power Supply Voltage (over lifetime)

7.1.5.4 Operation Time

Index	Subindex	Name	Data type	Access rights	Value range	Description
1000	–	Baumer Command	Int32	W		Operation Time Reset
211	1	Operation Time. Powerup	Int32	R		Powerup Operation Time
211	2	Operation Time. Re- setable	Int32	R		Resetable Operation Time
211	3	Operation Time. Life- time	Int32	R		Lifetime Operation Time
74	2	Unit Selection. Time	Int16	R/W		Selection between time units: <ul style="list-style-type: none"> ■ Second ■ Minute ■ Hour

7.1.5.5 Histogram

Index	Subindex	Name	Data type	Access rights	Value range	Description
Power Supply						
262	1	Power Supply Voltage Lifetime Histogram.Mode	Uint8	R		Standard means: Linear partition of the range into bins.
262	2	Power Supply Voltage Lifetime Histogram Unit	Uint16	R		Indicates the unit
262	3	Power Supply Voltage Lifetime Histogram RangeStart	Uint32	R		Defines, where the range starts.
262	4	Power Supply Voltage Lifetime Histogram RangeEnd	Uint32	R		Defines, where the range ends.
262	5	Power Supply Voltage Lifetime Histogram Nbr of Bins	Uint8	R		Number of bins
262	11 ... 26	Power Supply Voltage Lifetime Histogram Bin1...16	Uint32	R		Number of counts of each bin
Device Temperature						
265	1	Temperature Lifetime Histogram.Mode	Uint8	R		Standard means: Linear partition of the range into bins.
265	2	Temperature Lifetime Histogram Unit	Uint16	R		Indicates the unit
265	3	Temperature Lifetime Histogram RangeStart	Uint32	R		Defines, where the range starts.
265	4	Temperature Lifetime Histogram RangeEnd	Uint32	R		Defines, where the range ends.
265	5	Temperature Lifetime Histogram Nbr of Bins	Uint8	R		Number of bins

Index	Subindex	Name	Data type	Access rights	Value range	Description
265	11 ... 26	Temperature Lifetime Histogram Bin1...16	Uint32	R		Number of counts of each bin
Distance						
1000	–	Baumer Command	Int32	W		Distance Histogram Reset
257	1	Distance Resetable Histogram.Mode	Uint8	R		Standard means: Linear partition of the range into bins.
257	2	Distance Resetable Histogram. Unit	Uint16	R		Indicates the unit
257	3	Distance Resetable Histogram. RangeStart	Uint32	R		Defines, where the range starts.
257	4	Distance Resetable Histogram. RangeEnd	Uint32	R		Defines, where the range ends.
257	5	Distance Resetable Histogram.Nbr of Bins	Uint8	R		Number of bins
257	11 ... 26	Distance Resetable Histogram.Bin1...16	Uint32	R		Number of counts of each bin
Frequency						
1000	–	Baumer Command	Int32	W		Frequency Histogram Reset
260	1	Frequency Resetable Histogram.Mode	Uint8	R		Standard means: Linear partition of the range into bins.
260	2	Frequency Resetable Histogram. Unit	Uint16	R		Indicates the unit
260	3	Frequency Resetable Histogram. RangeStart	Uint32	R		Defines, where the range starts.
260	4	Frequency Resetable Histogram. RangeEnd	Uint32	R		Defines, where the range ends.
260	5	Frequency Resetable Histogram.Nbr of Bins	Uint8	R		Number of bins
260	11 ... 26	Frequency Resetable Histogram.Bin1...16	Uint32	R		Number of counts of each bin

7.2 qTeach®

7.2.1 Teach level overview

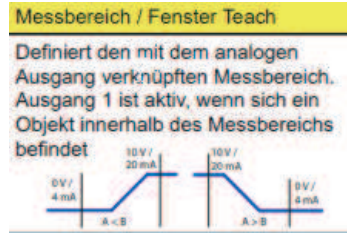
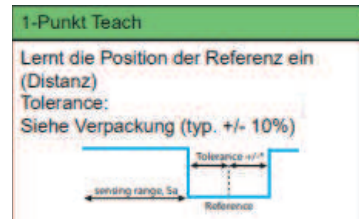
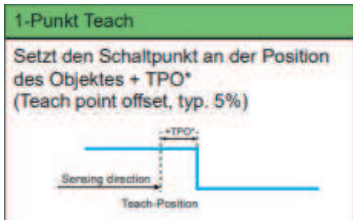

Legende

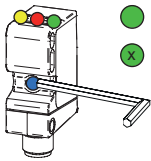

- LED leuchtet
- x LED blinkt x Hz

Betriebsmodus

LED Indikation	Betriebsanzeige	Kurzschluss	Ausgang 1 aktiv	Ausgang 1 Signal nahe der Schwelle	Ausgang 2 aktiv	Ausgang 2 Signal nahe der Schwelle	qTeach verwendbar
Grün	●	①					
Gelb			●	⑧			
Rot					●	●	
Blau							●

Teach-in Modus: siehe Teach-in Anweisung

- DE
- OT 500.S
 - OT 500.D
 - OT 500.G
 - ⌚ 2-4 s = x Sekunden Werkzeug an blaue LED halten
 - ⌚ = x Sekunden Idel Zeit, hier einfach warten
 - 🎯 = TAP!, 0,2 Sekunden Werkzeug an blaue LED tippen

Level 1

- ⌚ 2-4 s
- ② ●

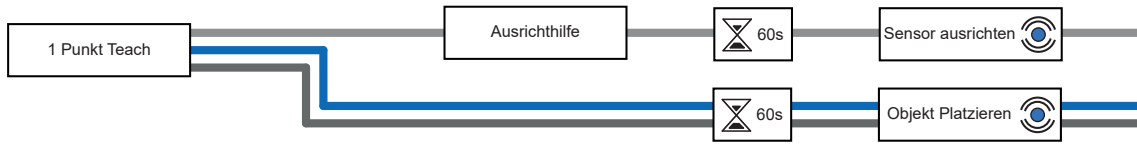

Level 2

- ⌚ 4-6 s
- ② ●

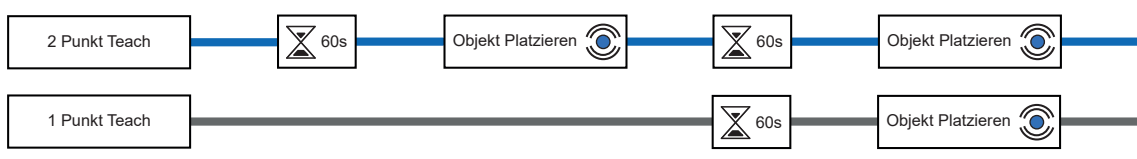

Level 3

- ⌚ 6-8 s
- ② ●

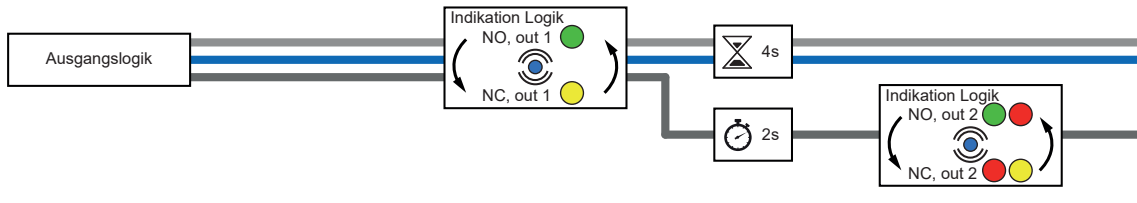

Level 4

- ⌚ 8 s
- ① ●



